

A-CLASS

Accolade

DESIGN, INSTALLATION AND SERVICING INSTRUCTIONS



kiwa
approved
product



UK WATER SUPPLY
REGULATIONS

kiwa
approved
product



UK BUILDING REGULATIONS

benchmark™

*The code of practice for the installation,
commissioning & servicing of central heating systems*

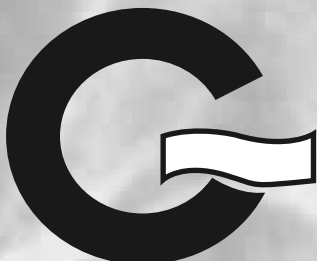

An unvented hot water storage unit complying with the requirements of Building Regulations Approved Document G3.

Please read these instructions before commencing installation.

In the interest of continuously improving the Accolade^{A Class} range, Gledhill Water Storage Ltd reserve the right to modify the product without notice, and in these circumstances this booklet, which is accurate at the time of printing, should be disregarded.

CONTENTS

ISSUE 5: 06-08

Section	Page
1.0 DESIGN	
1.1 Introduction	3
1.2 Technical Data	6
1.3 System Details	12
2.0 INSTALLATION	
2.1 Site Requirements	20
2.2 Installation	21
2.3 Commissioning	29
3.0 SERVICING	
3.1 Annual Servicing	32
3.2 Changing Components	32
3.3 Short Parts List	33
3.4 Fault Finding	35
Appendix 'A'	36
Appendix 'B'	37
Appendix 'C'	40
Appendix 'D'	41
Terms & Conditions	42



*The code of practice for the installation,
commissioning & servicing of central heating systems*

Building Regulations and Benchmark Commissioning

The Building Regulations (England & Wales) require that the installation of a heating appliance be notified to the relevant Local Authority Building Control Department. From 1st April 2005 this can be achieved via a Competent Person Self Certification Scheme as an option to notifying the Local Authority directly. Similar arrangements will follow for Scotland and will apply in Northern Ireland from 1st January 06.

CORGI operates a Self Certification Scheme for gas heating appliances.

These arrangements represent a change from the situation whereby compliance with the Building Regulations was accepted if the Benchmark Logbook was completed and this was then left on site with the customer).

With the introduction of a self certification scheme, the Benchmark Logbook is being replaced by a similar document in the form of a commissioning check list and a service interval record is included with all gas appliance manuals. However, the relevant Benchmark Logbook is still being included with all Thermal Storage products and unvented cylinders.

Gledhill fully supports the Benchmark aims to improve the standards of installation and commissioning of central heating systems in the UK and to encourage the regular servicing of all central heating systems to ensure safety and efficiency.

Building Regulations require that the heating installation should comply with the manufacturer's instructions. It is therefore important that the commissioning check list is completed by the competent installer. This check list only applies to installations in dwellings or some related structures.

1.0 DESIGN

1.1 INTRODUCTION

The Accolade^{A-CLASS} range of floor standing indirectly heated unvented hot water storage appliances is designed to provide domestic hot water at mains pressure. All models are designed for gas or oil fired heating and hot water systems with boiler capacities up to a maximum of 45kW. All models are fitted with a 6kW 'Switch' emergency electric backup system for domestic hot water or heating and hot water water in the event the boiler fails. The Accolade^{A-CLASS} appliances are factory fitted with all the necessary safety and control equipment for connecting to the cold water mains, boiler and heating system.

These instructions cover all the models and must be followed. These appliances have been certified for safety and the appliance and installation specifications of the appliances must not be modified unless recommended by Gledhill Water Storage Limited.



SAFETY

- 1. The Building Regulations (Approved Document G3) 2002 cover the installation of unvented storage water heating equipment and these require that the installation of an unvented unit shall only be carried out by a person competent to do so (as defined in the Approved Document) and that the Local Authority shall be notified of the intention to carry out the installation of one of these types of appliances.**
- 2. The system must be installed in accordance with the Water Supply Regulations, Building Regulations and relevant NHBC requirements.**
- 3. As the Accolade^{A-CLASS} is an unvented appliance it should not be used where steam is the primary heating medium, or with solid fuel boilers, or in situations where annual inspection/maintenance is likely to be neglected.**

1.0 DESIGN

1.1 INTRODUCTION

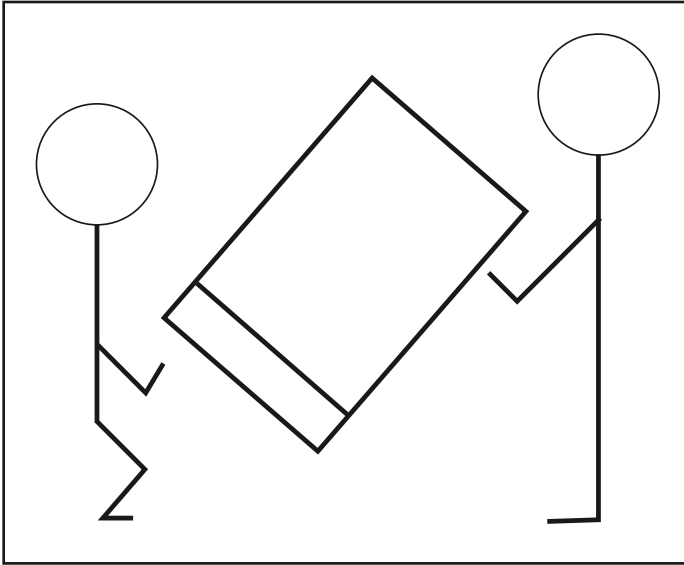

IMPORTANT NOTICES

1. Handling and Storing the Appliance

This appliance should be handled carefully to avoid damage and the recommended method is detailed below.

When lifting the unit:-

- Use a team lift
- Work with someone of similar build and height if possible.
- Choose one person to call the signals
- Lift from the hips at the same time, and then raise the unit to the desired level.
- Move smoothly in unison.

The appliance is supplied shrink wrapped on a timber installation base. Carrying handles are provided in the back of the casing.

If the unit needs to be stored prior to installation it should be stored upright in a dry environment and on a level base/floor.

Note: Although the above guidance is provided any manual handling/lifting operations will need to comply with the requirements of the Manual Handling Operations Regulations issued by the H.S.E. See Appendix D at the rear of this manual.

The appliance can be moved using a sack truck on the left hand face although care should be taken and the route should be even. In apartment buildings containing a number of storeys we would recommend that the appliances are moved vertically in a mechanical lift. If it is proposed to use a crane expert advice should be obtained regarding the need for slings, lifting beams etc.

2. System Installation

Any installation must be in accordance with the relevant requirements of the current issue of Local Building Regulations, the Water Supply Regulations, Health & Safety Document No. 635 and the Electricity at Work Regulations 1989. The detailed recommendations are contained in the current issue of the following British Standards and Codes of Practices: -

BS 5440 Pts. 1 & 2; BS 5449; BS 5546; BS 7074 Part 1; BS 6700; BS 6798; BS 6891, BS 7593, IGE/UP/7/1998

3. Equipment Selection

This information is provided to assist generally in the selection of equipment. Responsibility for selection and specification of our equipment must, however, remain that of our customers and any expert or consultants concerned with the installations).

Please note: -

We do not accept any responsibility for matters of design selection or specification or the effectiveness of an installation containing one of our products unless specifically asked in writing to do so.

All goods are sold subject to our Conditions of Sale which are set out in the Appendix to this document.

Warning

To comply with the Building Regulations requirements this appliance must be serviced and installed by a competent person suitably trained and registered to install unvented heating system equipment.

As part of the industry wide 'Benchmark' initiative all Accolade^{A-CLASS} appliances now include a Benchmark Installation, Commissioning and Service Record Logbook. Please read this carefully and complete all sections relevant to this appliance. Failure to do so may affect warranty.

Modifications should NOT be made to this product. If any components in this appliance are replaced and re-commissioned in the field then these must be obtained from Gledhill Water Storage Ltd to ensure continued safe operation and must not be tempered with. This applies particularly to the immersion heaters which must incorporate an overheat thermostat.

SAP

Details of how to enter this product in SAP are available. Please request a copy of the latest SAP Data which covers this and all other Gledhill Water Storage Products.

1.0 DESIGN

1.1 INTRODUCTION

Description

The Accolade^{A-CLASS} is a floor standing packaged mains pressure unvented hot water appliance and uses a twin copper cylinder configuration which ensures that all the water content is heated to a uniform temperature as well as reducing the risk of legionella and corrosion. All cylinders are manufactured in accordance with the requirement of BS7206:1990. All models of the Accolade are factory fitted with all the necessary safety and control equipment for connecting to the domestic water systems, the boiler and the heating system (see table 1.2 and figure 1.1).

All models are designed to be heated indirectly by a gas or oil fired boiler and are suitable for use with both open vented and sealed heating systems. These appliances are also fitted with a 6kW 'Switch' emergency electric backup system in the event of a boiler failure. Two switches on the front of the appliance allow this to be used for hot water only or heating and hot water if required. This should be sufficient in most cases to satisfy the heating requirements of a typical property in an average day although in larger properties and on very cold days a choice between a lower temperature or the area to be heated fully will need to be made (see table 1.1)

All models except ACA125 IND are fitted with a secondary return tapping as standard. This is blanked 22mm diameter copper pipe on the top - right hand - rear of the appliance. If secondary hot water circulation is installed, then an additional expansion vessel may be necessary. Typical primary hot water circulation system design is discussed further in section 1.3 of this manual.

Design heating load (kW)	4.0	6.0	8.0	10.0	12.0	14.0
Radiator design output (kW)	4.8	7.2	9.6	12.0	14.4	16.8
Heat output required on design-day (kW)	3.3	5.0	6.6	8.3	9.9	11.6
Heat output required on average winter day (kW)	2.1	3.1	4.2	5.2	6.3	7.3
Radiator output with switch (kW)	2.6	3.9	5.2	5.8	5.8	5.8
Heat load satisfied on design-day (%)	77.9	77.9	77.9	70.2	58.5	50.2
Heating load satisfied on average day (%)	100.0	100.0	100.0	100.0	92.6	79.4

1.0 DESIGN

1.2 TECHNICAL DATA

Table 1.2 Factory fitted and supplied components	
	Models
	ACA125 IND ACA150 IND ACA180 IND ACA210 IND ACA240 IND
Factory fitted and wired standard equipment (see figure 1.1)	
1. Mains pressure inlet control group consisting of Non-return valve, Pressure regulator, Strainer, Expansion relief valve and balanced cold water outlet	Yes - Non adjustable factory set operating pressure - 1.5 bar
2. Pressure and temperature (P&T) relief valve	Yes - Non-adjustable factory set operating pressures
3. Tundish	Yes - 2 No for items 1 and 2
4. Over heat thermostat	Yes - manual reset, non adjustable and not accessible to user
5. Control thermostat	Yes, Adjustable, not accessible to user
6. Anti-vacuum valve	Yes
7. Wiring centre	Yes
8. Domestic hot water expansion vessel(s)	Yes
9. Hot water zone valve	Yes
10. Space heating zone valve	Yes
11. System pump	Yes
12. Automatic bypass valve	Yes
13. Grasslin electro-mechanical clock	Yes
14. 6kW switch emergency electrical backup with control and over heat thermostats	Yes - for backup in case of boiler failure
15. Drain cock	Yes
16. Ball-o-fix isolation valve	Yes
Optional Extras - to be requested at time of order	
Sealed System Kit	
1. Pressure gauge	Yes
2. Primary (heating) circuit expansion vessel	Yes
3. Filling loop	Yes
4. Expansion relief	Yes
Open Vented Kit	
1. Feed and Expansion cistern with lid	Yes
2. Ball valve and float	Yes
3. Over flow and cold feed tank connectors	Yes
Grasslin digital clock	Yes
No clock	Yes
Remote clock fixing kit	
SRD Kit (scale inhibitor)	Yes
Flexible connection kit	Yes
Grundfos UPS 15/60 pump	Yes (125 & 150 only)
Hot and cold manifold sets (1 or 2)	

1.0 DESIGN

1.2 TECHNICAL DATA

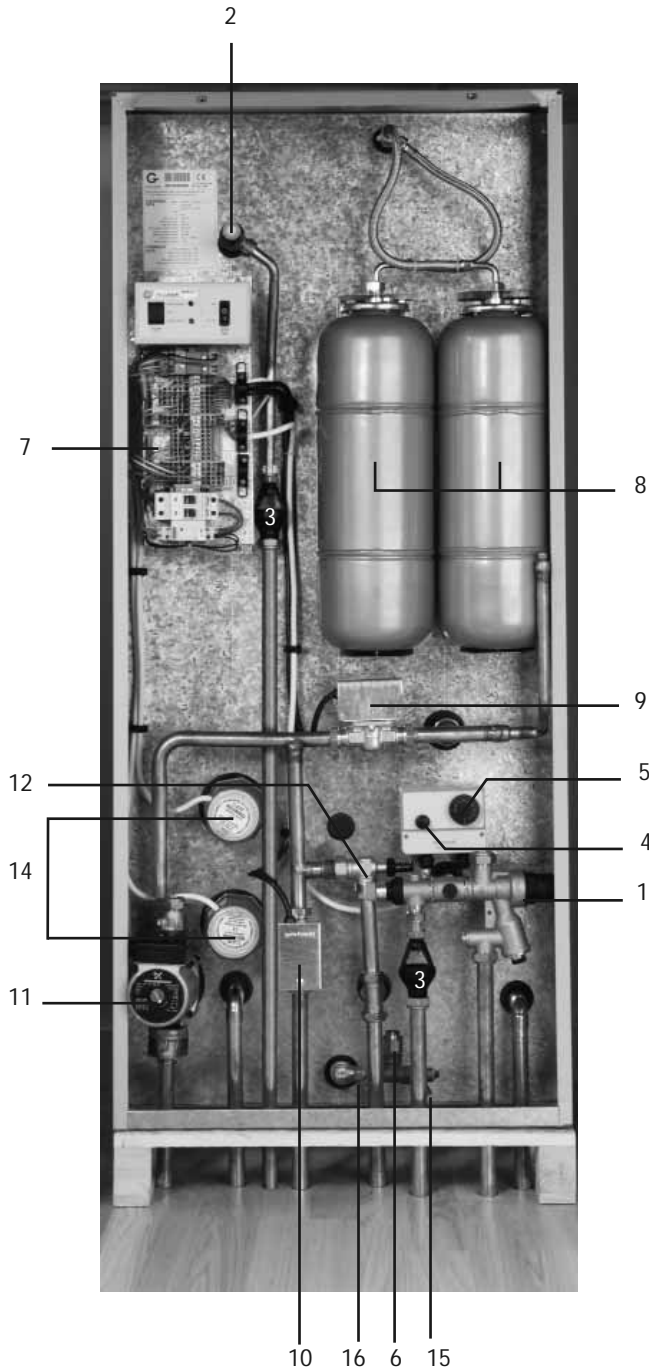
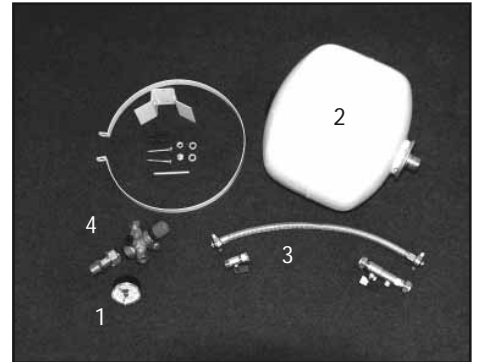

Figure 1.1
Factory fitted components (see table 1.2)



Primary Sealed System Kit
(optional extra)



Open Vented Primary Kit
(optional extra)

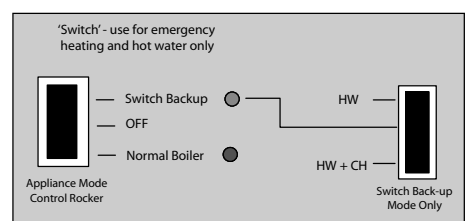
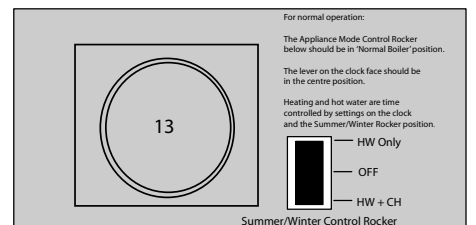

Front Panel

1.0 DESIGN

1.2 TECHNICAL DATA

- Optional
 1. Sealed system kit
 2. Open vented kit

* available as part of an optional kit
 ** minimum allowance in the Water Regulations for access to ballvalve

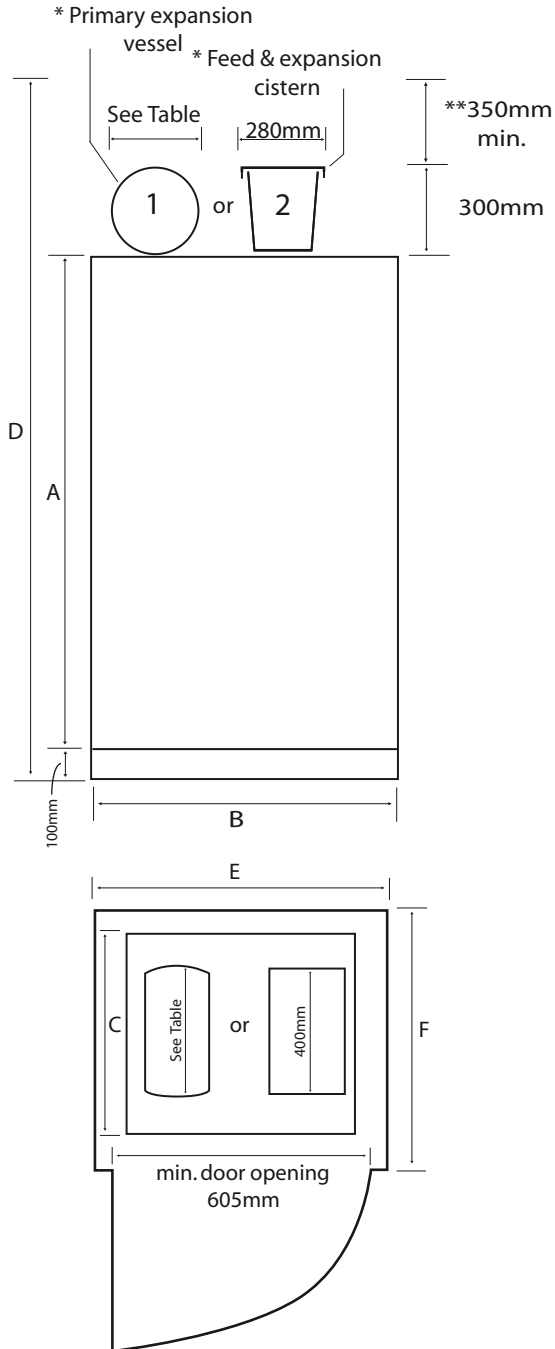

Figure 1.2 Minimum cupboard dimensions

Appliance Dimensions			
Model	Height (A)	Width (B)	Depth (C)
ACA125_IND	1080	595	595
ACA150_IND	1140	"	"
ACA180_IND	1370	"	"
ACA210_IND	1600	"	"
ACA240_IND	1950	"	"

Note: The appliance dimensions do not allow for the 100mm installation base.

Minimum Cupboard Dimensions			
Model	Height (D)	Width (E)	Depth (F)
ACA125_IND	1830	700	600
ACA150_IND	1890	"	"
ACA180_IND	2120	"	"
ACA210_IND	2350	"	"
ACA240_IND	2700	"	"

The dimensions above are for the Appliance complete with F & E Cistern (for use with OV primary/heating systems) being in the same cupboard.

If the appliance is fitted with a primary expansion vessel (for use with a sealed primary/heating systems) 300 mm can be deducted from the height.

The table of minimum cupboard dimensions only allow the minimum space required for the appliance (including the heating system F & E cistern or expansion vessel and installation base) and any extra space required for shelving etc in the case of airing cupboards etc must be added.

Expansion Vessel Sizes			
Model	Capacity	Size-mm	Stock code
ACA125_IND	8 litre	515 x 160 dia	TBA
ACA150_IND	8 litre	515 x 160 dia	TBA
ACA180_IND	12 litre	290 x 270 dia	XG164
ACA210_IND	12 litre	290 x 270 dia	XG164
ACA240_IND	18 litre	400 x 270 dia	XG009

1.0 DESIGN

1.2 TECHNICAL DATA

Model Selection Guide

General selection criterion is shown in Technical Data table 2.1. However, before selecting the model, the hot water requirements of the dwelling should be correctly assessed.

Appliance Location

The Accolade^{A-CLASS} must be installed on a flat surface, which is capable of supporting the weight of the appliance and any other ancillary equipment.

The minimum airing cupboard dimensions and the clearances required for installation and service are shown in figure 1.2.

The appliance is designed to be installed on the plinth supplied with the appliance. The pipe connection arrangement is shown in figure 1.3.

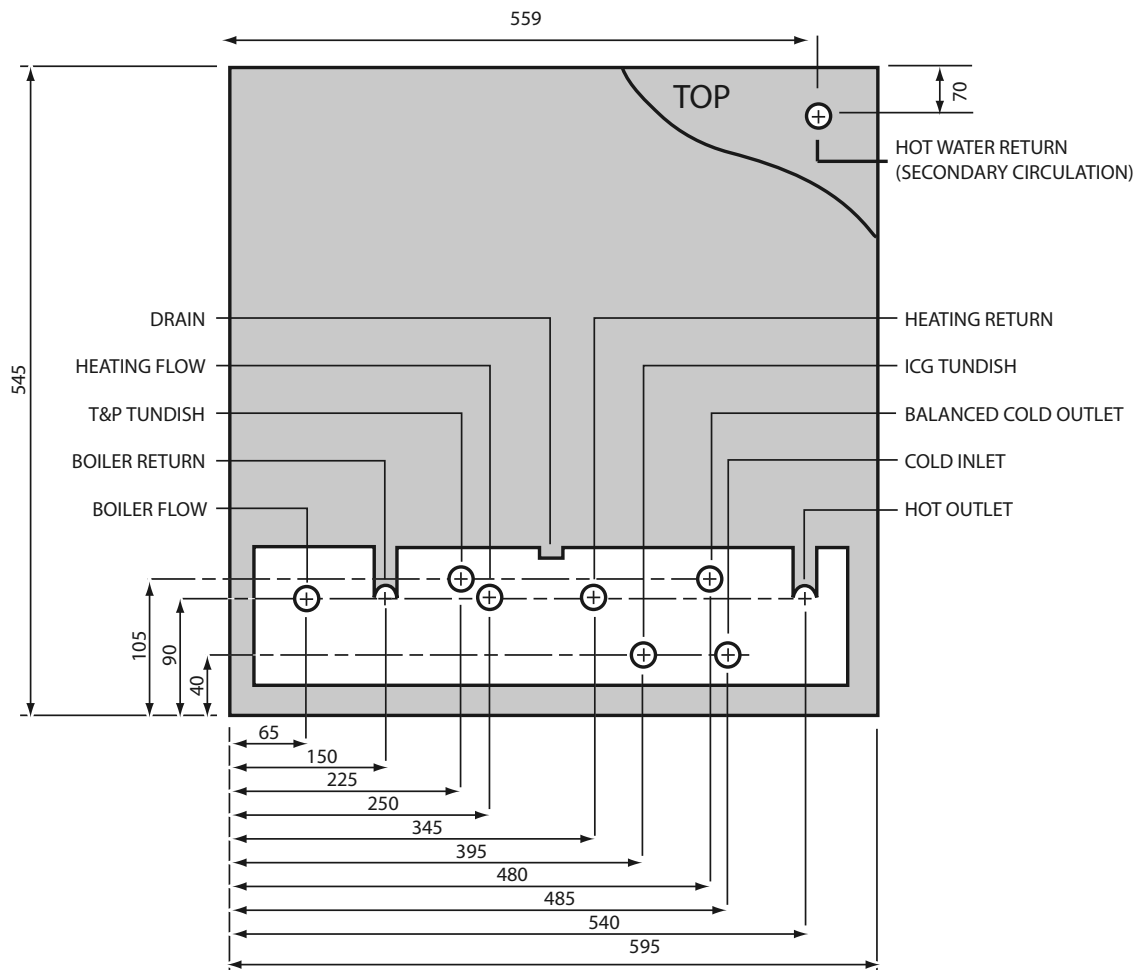

Figure 1.3 Connection Arrangement - Indirect

1.0 DESIGN

1.2 TECHNICAL DATA

Primary heat exchanger (i.e. coil) pressure loss of Accolade 2000 Models

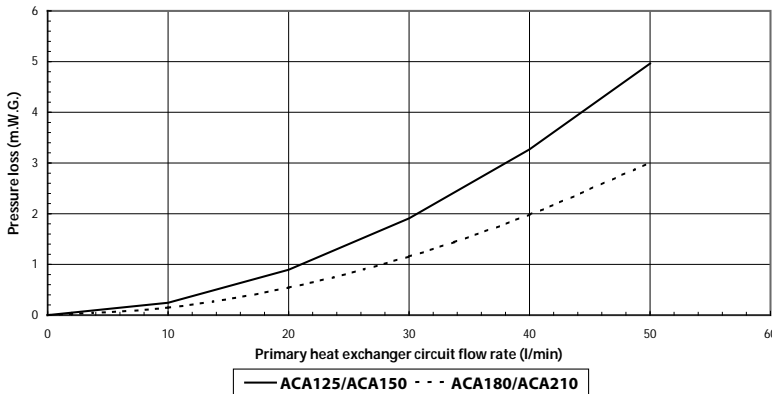

Figure 1.4 Net pump head available - Hot water only on

Heating circuit pressure loss of Accolade 2000 Models

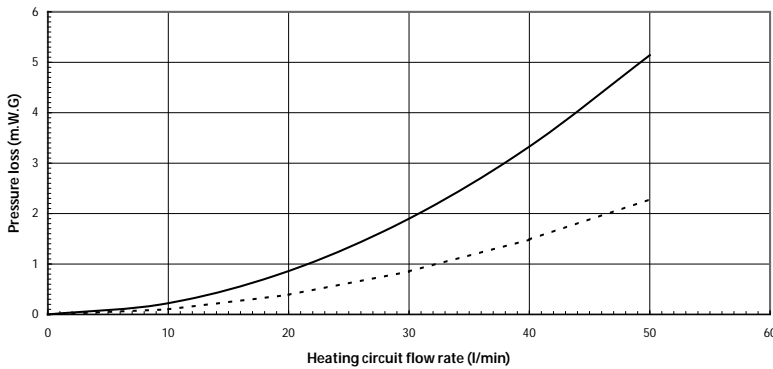

Figure 1.5 Net pump head available - Heating only on

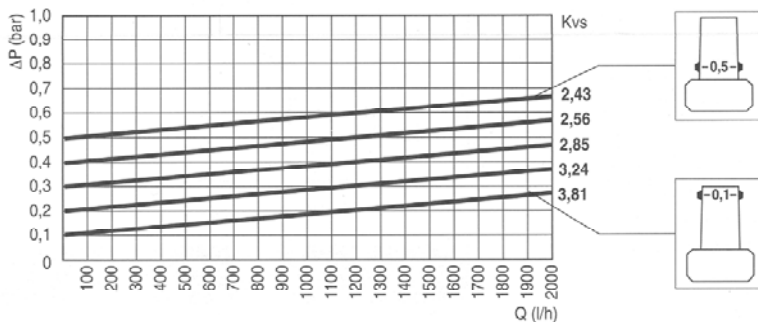

Figure 1.6 Automatic bypass valve characteristics

- General technical and performance data of the Accolade^{A-CLASS} range is given in table 2.1.
- All models are fitted with high performance primary heat exchangers and are supplied with either Grundfos UPS 15-50 or UPS 15-60 factory fitted pumps. The net pump head available when hot water only is on and when space heating only is on is shown in figures 1.4 and 1.5 respectively. The control characteristic of the automatic bypass is shown in figure 1.6.
- In these appliances the mains inlet pressure regulating valve is set to 1.5 bar and this setting **MUST NOT** be adjusted. Therefore the flow rate from the appliance depends upon the resistance of the hot water supply network, capacity of the incoming mains and the characteristics of the pressure regulating valve.

Electricity Supply

One mains supply rated at 30A, 230V~, 50Hz is required.

Minimum external fuse rating and the main supply cable ratings are given in "2.1. Site Requirements" section of this manual. All fuses must be ASTA approved to BS 1362. This appliance **MUST BE EARTHED**.

All external wiring to the appliance must be in accordance with the latest I.E.E. Wiring Regulation, and any local regulations which may apply.

The appliance shall be supplied from a 30A fused double pole switched isolator with a contact separation of at least 3mm in both poles.

This must be suitably labelled, provide complete electrical isolation and be within 1 metre of the Accolade^{A-CLASS} Unit.

In the event of an electrical fault after installation of the appliance, preliminary electrical checks must be carried out i.e. Earth Continuity, Short Circuit, Polarity, and Resistance to Earth.

1.0 DESIGN

1.2 TECHNICAL DATA

Table 2.1 Technical specification of Accolade A-Class		Accolade A-Class Indirect Models				
		ACA125 IND	ACA150 IND	ACA180 IND	ACA210 IND	ACA240 IND
Weight (kg)	Empty	59	72	84	96	118
	Full	149	190	229	267	333
Temperature set-point of thermostats (°C)	Control thermostat (CT)	60				
	OHT 1	80				
	P&T Valve	90				
	IH CT (inside heater head)	60				
	IH OHT (inside heater head)	85				
Pressure set point (bar)	Inlet pressure regulator	1.5				
	Expansion relief valve	3.0				
	P&T valve	4.0				
	Primary expansion relief valve	3.0				
DHW (potable water) expansion vessel sizing	Expansion coefficient (%)	4.00				
	Expansion volume (l)	3.60	4.72	5.80	6.84	8.60
	Expansion vessel (l)	8.4	11.1	13.6	16.0	20.1
Primary i.e. heating circuit expansion vessel sizing	Maximum boiler rating (kW)	15	15	20	25	35
	Maximum design heating load (kW)	10.5	10.5	15	19.5	28.5
	Water content (litres)	47.25	47.25	67.5	87.75	128.25
	Vessel charge pressure (bar)	1.0				
	Primary exp relief valve setting	3.0				
	Expansion coefficient (%)	5.0				
	Expansion vessel (l)	5.53	5.53	7.91	10.28	15.02
Boiler/Heating Circuit						
Pump: Grundfos UPS 15-50 (22mm connections)		FF-S	FF-S	FF-S		
Pump: Grundfos UPS 15-60 (28mm connections)					FF-S	FF-S
HTG Zone valve_22mm: Honeywell V4043 with removable head		FF-S	FF-S	FF-S		
HTG Zone valve_28mm: Honeywell V404 with removable head					FF-S	FF-S
Grasslin electro-mechanical clock		FF-S				
Bypass valve: Comap Automatic-factory set at 2.5		FF-S				
Pressure relief valve		FK-O				
Expansion vessel(s) supplied as part of sealed system kit (FK-O) Zilmet OEM-PRO Rectangular - charged to 1.0 bar		13N600FG00 (7.5 l) 492x203x118	13N600FG00 (7.5 l) 492x203x118	13N6001000 (10 l) 492x203x150	13N6001200 (12 l) 492x203x170	13Q0001800 (18 l) 445x350x158
Filling loop		FK-O				
Pressure gauge		FK-O				
DHW Circuit						
Anti-vacuum valve: GT056		FF-S				
Combined CT & OHT 1: Honeywell dual Aquastat TS9430.51/04224		FF-S				
HW zone valve 22mm: Honeywell V4043 with removable head		FF-S	FF-S	FF-S		
HW zone valve 28mm: Honeywell V4043 with removable head					FF-S	FF-S
P&T valve: Honeywell TP152-3/4ZB set at 4.0 bar and 90°C		FF-S				
Inlet control group: Honeywell ICS 22mm with PRV set at 3.0 bar, PR set at 1.5 bar		FF-S				
Tundish(s)		FF-S (2 off, For ERV & For P&T valve)				
Expansion vessels supplied as part of standard kit (FF-S): Zilmet HYDRO-PRO Circular - charged to 1.5 bar.		1x8 L (510842160)	2x8 L (510842160)	2x8 L (510842160)	2x8 L (510842160)	3x8 L (510842160)
Electric Heating						
Immersion heater: reding 3kW Type GU11TC		2 x FF-S (Acting as Switch backup)				
IH control thermostat: Integral part of IH		2 x FF-S				
IH OHT: Integral part of IH		2 x FF-S				
User Controls						
Grasslin digital clock		FK-O				
FF-S: Factory fitted standard item FK-S: Part of factory supplied kit FK-O: Part of factory supplied optional kit						

1.0 DESIGN

1.3 SYSTEM DETAILS

Hot and Cold Water System

- a. All recommendations with regard to pipe work systems in this manual are generally based on the use of BS/EN Standard copper pipework and fittings.
- b. However a plastic pipework system can be used in place of copper internally as long as the chosen system is recommended by the manufacturer for use in cold and hot water systems and is designed and installed fully in accordance with their recommendations.
- c. This is particularly important in relation to use of push fit connections when using the optional flexible hose kits (See Installation and Wiring section of this document),
- d. It is also important that if an alternative pipework material/system is chosen, the manufacturer confirms that the design criterion for the new system is at least equivalent to the use of BS/EN Standard copper pipework and fittings.
- e. If the incoming mains pressure exceeds 6 bar at any time in a 24 hour cycle then a pressure regulating valve set at 3.5 bar should be fitted downstream of the stop tap where the cold supply enters the property.
- f. Equipment used in the system should be suitable for a working pressure of up to 5 bar.

Mains cold water supply

- a. Accolade^{A-CLASS} is designed to be connected directly to the mains. The combination inlet valve incorporates the required check valve. The hot water flow rate achievable from the Accolade^{A-CLASS} is directly related to the adequacy of the cold water mains serving the property. For this reason the cold water supply to the dwelling must be capable of providing for those services which could be required simultaneously and this maximum demand should be calculated. Also if a water meter is fitted its nominal rating should match the anticipated maximum simultaneous hot and cold water demand calculated in accordance with BS 6700. This could be 60 litres per minute in some properties. 30 litres per minute is the minimum flow rate which is recommended for an adequate mains pressure system to any property.

The Building Regulations L1A: New dwellings/L1B: Existing dwellings and the requirements set out in the Domestic Heating Compliance Guide specify that "where the mains water hardness exceeds 200ppm provision should be made to treat the feed water to water heaters and the hot water circuit of combination boilers to reduce the rate of accumulation of lime scale".

To comply with this requirement the hardness of the mains water should be checked by the installer and if necessary the optional factory fitted in-line scale inhibitor should be specified at the time of order for hardness levels between 200 and 300 ppm (mg/l).

Where the water is very hard ie 300ppm (mg/l) and above the optional polyphosphate type, inhibitor should be specified at the time of order. However, this will need to be fitted by the installer at a suitable point in the cold water supply to the appliance.

- b. The combination valve fitted to the Accolade^{A-CLASS} incorporates a pressure regulating valve set to provide a static operating pressure of 1.5 bar. On this basis there must be at least 2.0 bar pressure at the inlet to the appliance. This pressure must be dynamic (not static) and be available at the appliance when local demand is at its maximum. For optimum performance, and for larger properties, we would recommend that the dynamic pressure is in the range of 2.5 - 3.5 bar.
- c. The combination valve also incorporates an expansion relief valve. The discharge from this can be connected into the discharge pipe from the P & T valve. Further details of how to treat this discharge are provided later in this manual.
- d. As a general guideline, although a 15mm service may be sufficient for smaller dwellings with one bathroom, a 22mm service (25mm MDPE) is recommended and should be the minimum for larger dwellings.

1.3 SYSTEM DETAILS

Cold and hot water distribution network

- As a minimum it is recommended that the cold supply to the appliance internally is run in 22mm copper or equivalent in plastic and then from the appliance, hot and cold services are in 22mm past the draw-off to the bath as shown schematically in figure 2.1. For large properties bigger sizes will be necessary and these should be proved by calculation in accordance with BS6700.
- The highest hot or cold water draw-off point should not exceed 4 metres above the appliance.
- In typical dwellings, the cold water supply to any mixer fittings (other than dual outlet fittings) should be taken from the balanced cold outlet connection on the appliance. However, in larger dwellings with a number of bathrooms and en-suites and long pipe runs, the balanced cold supply must be provided with its own pressure regulating valve (set at the same pressure as the one provided with the appliance ie 1.5 bar static) and not taken from the appliance. When a separate pressure regulating valve is used for the balanced cold water supply, it is recommended that a small expansion vessel (0.25 - 0.5 litre) is fitted after the pressure regulator to accommodate the pressure rise caused by the increase in temperature of the balanced cold water.
- If the supply to the mixer fittings (other than a dual outlet type) is not taken from the balanced supply the system will become over pressurized and cause the pressure relief valve to discharge. Over time this could also cause the premature failure of the appliance itself which will not be covered by the warranty.
- Whenever possible the hot and cold water supply to a shower-mixing valve should be the first draw-off point on each circuit.
- It is important that the cold water pipe work is adequately separated from any heating/hot water pipe work to ensure that the water remains cold and of drinking water quality.

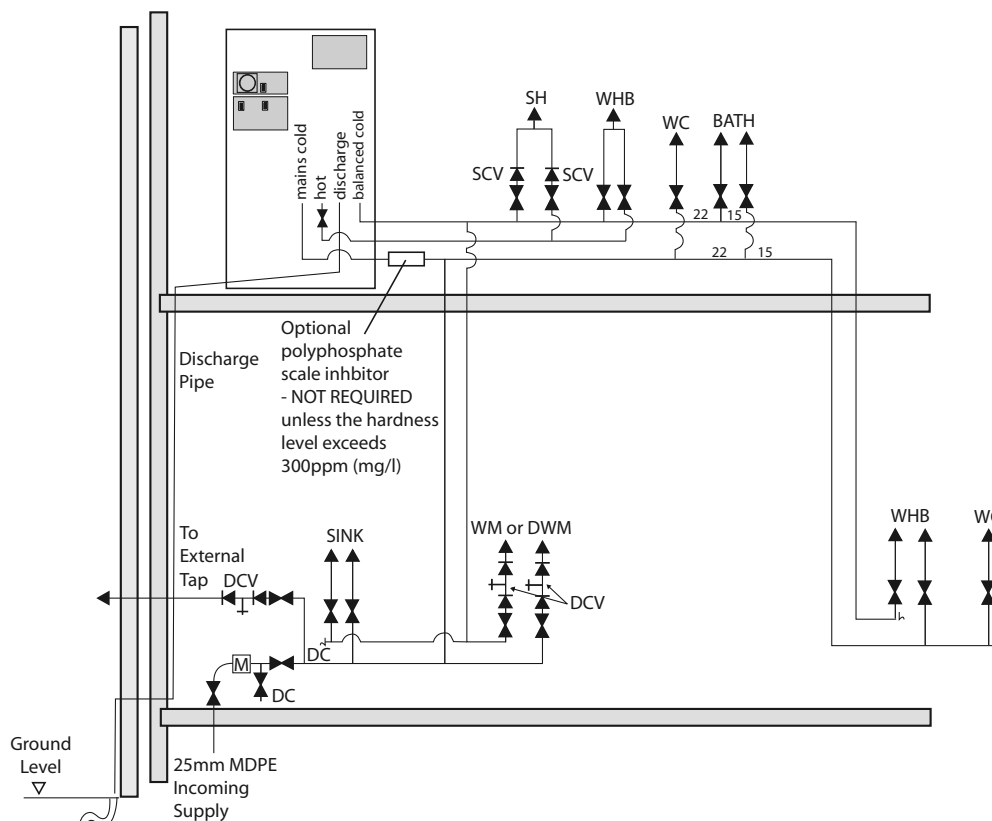

Figure 2.1 Typical cold and hot water network (to a smaller property)

Cold supplies to single taps taken from the mains cold water system.
Cold supplies to mixer taps only to be taken from the balanced cold water connection on the combination valve.

1.0 DESIGN

1.3 SYSTEM DETAILS

Taps and Shower Fittings

- a. Ensure that all terminal fittings are suitable for mains pressure. Use aerated taps whenever possible to prevent splashing.
- b. Any type of shower mixing valve can be used as long as both the hot and cold supplies are mains fed. However, all mains pressure systems are subject to dynamic changes particularly when other hot and cold taps/showers are opened and closed, which will cause changes in the water temperature at mixed water outlets such as showers. For this reason and because these are now no more expensive than a manual shower we strongly recommend the use of thermostatic showers with this appliance.
The shower head provided must also be suitable for mains pressure supplies. However, if it is proposed to use a 'whole body' or similar shower with a number of high flow/pressure outlets please discuss with the Gledhill technical department.
- c. Note that the shower fittings must comply with the backflow prevention requirements (Para 15, Schedule 2) of the Water Supply Regulations 1999.
- d. A bidet can be supplied from the Accolade^{A-CLASS} appliance as long as it is of the over rim flushing type and incorporates a suitable air gap.

Dead leg volumes and secondary hot water circulation

If the dead leg volume of the hot water draw-off pipework is excessive and the delivery time for hot water to be available at the tap is more than 60 seconds you may consider using:-

- a. Trace heating such as the 'Raychem HWAT' system. Please call Gledhill technical department for further details.
OR
- b. A secondary hot water circulation system as shown schematically in figure 2.2.

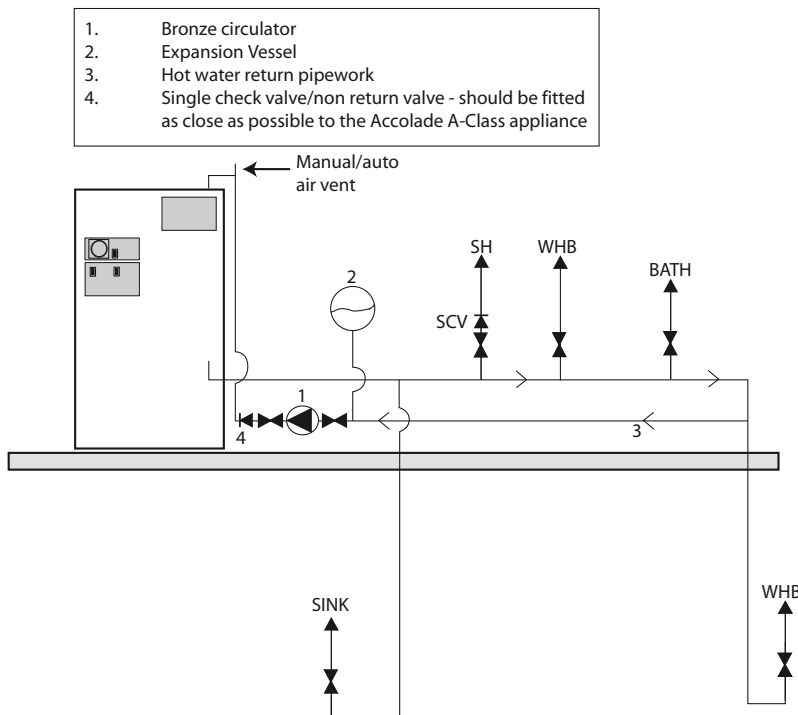

Figure 2.2 Schematic diagram of typical secondary hot water circulation

1. Hot flow and return pipework must be insulated
2. All components must be suitable for use on domestic unvented hot water storage systems

1.3 SYSTEM DETAILS

Space Heating System Design

General

Warning: Accolade^{A-CLASS} is an unvented hot water storage appliance and therefore it is not suitable for use with a solid fuel boiler, steam or any other uncontrolled heat source.

Model selection

All models are designed to be installed with any condensing or non condensing gas or oil fired boiler which has a controlled heat source and is fitted with an overheat thermostat.

The heating system design and installation must comply with the requirements of BS 6798 and BS 5449.

Although general model selection guidance is given in table 2.1 (section 1.2), it is recommended that the hot water demand should be determined before selecting the correct model.

Plastic pipework

All recommendations with regard to pipework systems in this manual are generally based on the use of BS/EN Standard copper pipework and fittings. However plastic pipework can be used in place of copper internally as long as it is recommended by the manufacturer and installed fully in accordance with their recommendations. Barrier type plastic pipework should always be used for these systems.

It is important to ensure that if the system is to be installed using plastic pipework it is designed and sized for plastic pipework. This is particularly important in relation to use of push fit connections to the appliance.

Boiler Sizing

The Accolade^{A-CLASS} is designed to operate in a 'flow share' mode i.e. the boiler may supply space heating and hot water demands simultaneously. Therefore a hot water allowance should be included when sizing the boiler and heating system in accordance with BS 5449.

1.0 DESIGN

1.3 SYSTEM DETAILS

Frost protection

If it is necessary to protect parts of the heating system or the boiler which are installed in unheated spaces (e.g. garage, outhouse and ventilated roof space), a frost thermostat(s) must be fitted. The Accolade^{A-CLASS} appliance should not be installed in a location where the contents could freeze.

User controls

Any type of 2 channel programmer or programmable room thermostat is suitable for use with the Accolade^{A-CLASS}. Suitable controls can be supplied as optional extras by Gledhill if required.

System bypass

An automatic bypass valve is built into the appliance to allow thermostatic radiator valves (TRV's) to be fitted. To meet the requirements of Building Regulations for a boiler interlock it is recommended that the radiator in the area where the room thermostat is installed should be fitted with lock shield valves on both connections.

The bypass valve is set at the factory to 2m head but this should be adjusted on site by the installer to ensure that there is an adequate (the minimum flow rate recommended by the boiler manufacturer) flow rate through the boiler when TRVs are closed.

Pump head

The net pump head available when hot water only or space heating only are on is shown in figures 1.4 and 1.5 respectively. The net pump head available for sizing the boiler radiator circuit should be calculated using these figures.

Sealed central heating system

Sealed system kit

An optional sealed system kit as follows can be supplied with the Accolade^{A-CLASS}

- Expansion relief valve set at 3.0 bar
- Pressure gauge (0 – 4 bar)
- Primary expansion vessel charged to 1.0 bar, (Size depends upon the model, see table 2.1)
- WRAS approved primary system filling loop

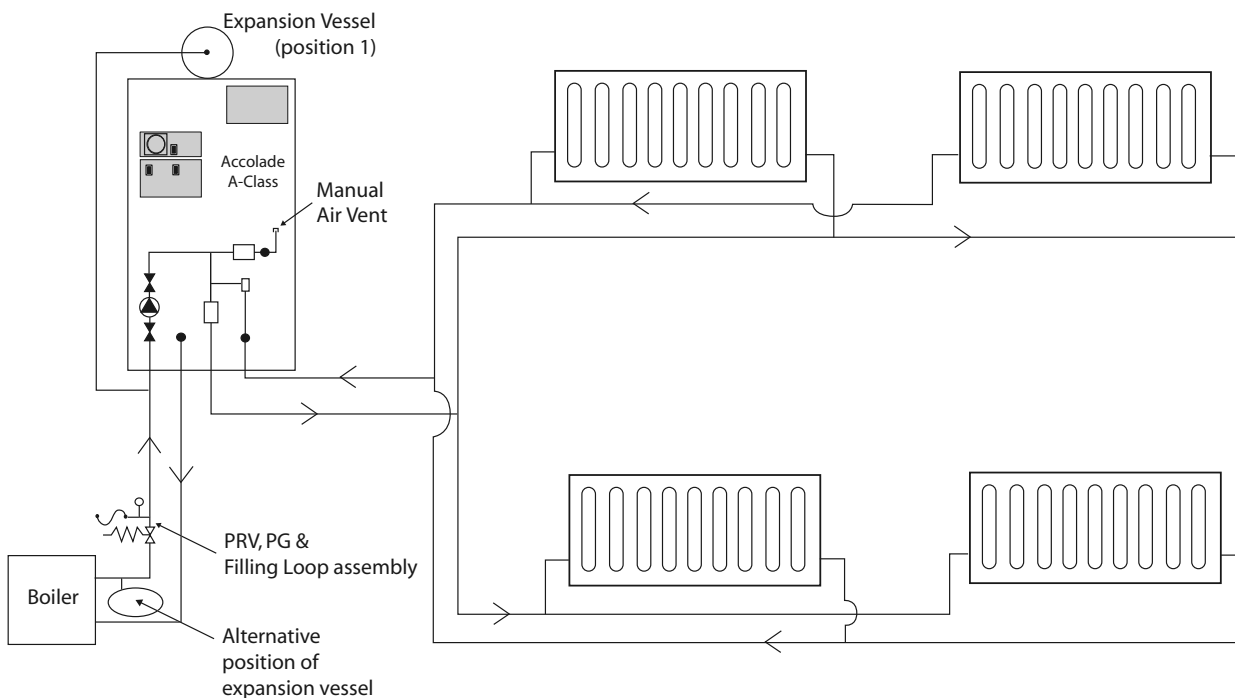

Figure 2.3 Schematic diagram of a sealed heating system

1.0 DESIGN

1.3 SYSTEM DETAILS

Pressure gauge and filling loop

Primary

The pressure gauge and the approved filling loop should be fitted at the system filling point which it is recommended should be adjacent to the boiler.

There shall be no permanent connection to the mains water supply for filling the system, even through a non-return valve without the approval of the Local Water Authority. The approved filling loop should be disconnected after commissioning the system.

Pressure relief valve

Primary

The pressure relief valve must be fitted in the boiler flow pipe adjacent to the boiler. There must no isolating valves or any such devices between the boiler and the pressure relief valve. The pressure relief valve should be fitted in a position where it is accessible for testing/inspection.

The method of fitting should ensure that discharge of water or steam cannot create a hazard to persons in or about the premises or damage to electrical components or wiring and the point of discharge shall be clearly visible.

The expansion vessel must accommodate the change in volume of system water when heated from 10°C to 110°C (see BS 5449:1990 clause 16.2). When calculating the system water content, the water content of the primary heat exchanger (see table 2.1) must be included. The expansion vessel requirements are shown in table 3.1. When ordering the optional sealed system kit it is the installers responsibility to check that the expansion vessel size is adequate for the primary/heating system.

Note 1

After first filling the system to a pressure of 1.0 bar at mains supply temperature (typically 15°C in summer), the total system (space heating and hot water) should be heated to its maximum temperature. If the primary pressure gauge indicates 2.6 bar or higher, then an additional expansion vessel may be required.

Note 2

If the system pressure required is more than 1.0 bar, then the expansion vessel charge pressure should be adjusted to match the primary system pressure and the expansion vessel size recalculated accordingly.

Table 3.1 Primary expansion vessel requirements

Safety valve setting (bar)	3.0			
Initial vessel charge pressure (bar)	1.0		1.5	
Initial system pressure (bar)	1.0	1.5	1.5	2.0
Total water content of system (l)	Expansion vessel volume (litres)			
20	2.2	3.8	3.1	6.6
40	4.4	7.6	6.2	13.2
60	6.5	11.4	9.4	19.9
80	8.7	15.2	12.5	26.5
100	10.9	19.0	15.6	33.1
120	13.1	22.8	18.7	39.7
150	16.4	28.5	23.4	49.7
180	19.6	34.2	28.1	59.6
For other volumes multiply the system content by factor	0.109	0.190	0.156	0.331

1.0 DESIGN

1.3 SYSTEM DETAILS

Open vented heating system

Open vented system kit

An optional open vented kit as follows can be supplied with the Accolade^{A-CLASS}

- Feed and expansion cistern with lid
- Ball valve & float
- 22mm Overflow pipe connector
- 15mm Cold feed tank connector

F & E cistern

The feed and expansion cistern, can be fitted on top of or up to 10m above the base of the appliance i.e. the maximum static pressure in the appliance must not exceed 1.0 bar (figure 2.4). The water level in the F & E cistern should be at least 250mm above the highest point of the system including the radiators.

Overflow pipe

The overflow/warning pipe should be installed using 20mm internal diameter pipe of a suitable material to comply with BS 5449 (such as copper). It should have a continuous fall and be discharged in a conspicuous external position. It should not have any other pipework directly branched into it.

Cold feed/expansion and safety/open vent

The safety/open vent should be connected into the boiler flow pipe ensuring that there is a continuous rise from the boiler to the point of discharge over the F & E cistern as shown schematically in figure 2.4. The open vent and cold feed should be run in a minimum of 22mm and 15mm copper (respectively) or equivalent to the feed and expansion cistern. There must no isolating valves or any such devices between the boiler and the safety/open vent termination point.

Discharge Arrangements

The P & T valve and Expansion Relief Valve (ERV) are both provided with tundishes. It is normal for these to be connected into a single 22mm discharge pipe but they can be run separately if required. The first 300mm of pipework below the tundish should be vertical and not contain any elbows/bends.

It is the requirement of Building Regulation Approved Document G3 that the discharge from an unvented hot water storage system is conveyed to where it is visible but will not cause danger to persons in or about the building. The discharge pipe from the appliance tundish should be fitted in accordance with these requirements.

The discharge pipe MUST terminate in a SAFE and VISIBLE position. For a 22mm discharge it must have an equivalent length of no more than 9 metres and it must have a continuous fall (1:200 minimum) throughout its length.

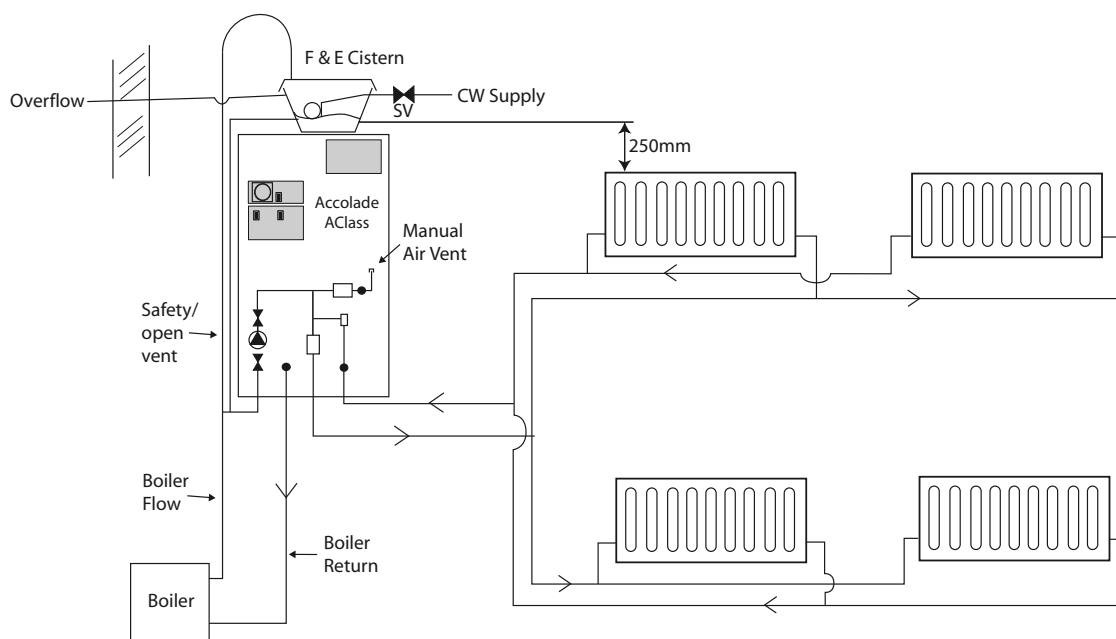

Figure 2.4 Schematic diagram of open vented heating system

1.3 SYSTEM DETAILS

In apartment/flat situations the discharge pipes can be connected into a single pipe which is discharged at low level. In this case the number should be limited to 6 to allow the fault to be easily traced. The single pipe should be at least one size larger than the largest individual discharge pipe connected to it.

The discharge can consist of scalding water and steam therefore the pipework should be metal.

The following locations for the discharge pipe are acceptable:

Low Level

- Into a gully below the grating but above the water level (see diagram 1).
- Onto the ground (drive, path or garden area). The pipe should discharge downwards and be no more than 100mm above ground level. A wire cage should be provided to prevent people coming into contact with scalding water (see diagram 2).

High Level

High level discharge is only acceptable if it is :

- onto a flat or pitched roof capable of withstanding high temperature water and at least 3m away from plastic guttering.
- or
- into a metal hopper and down pipe which terminates at low level (as described above.)

Discharge into a soil or waste pipe (whether plastic or metal) is not normally acceptable.

The proposals for the discharge pipe/ termination point should be discussed and agreed with the Building Control Officer prior to commencing any work.

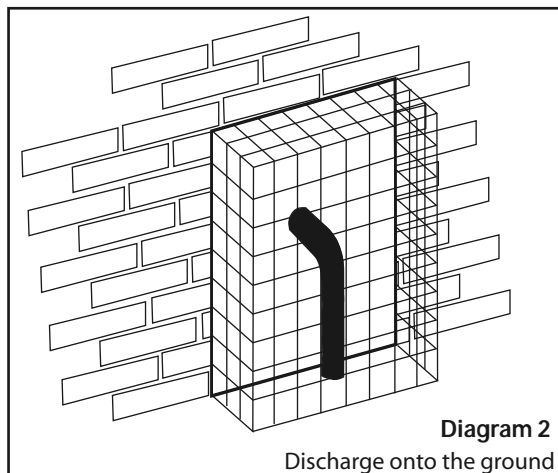
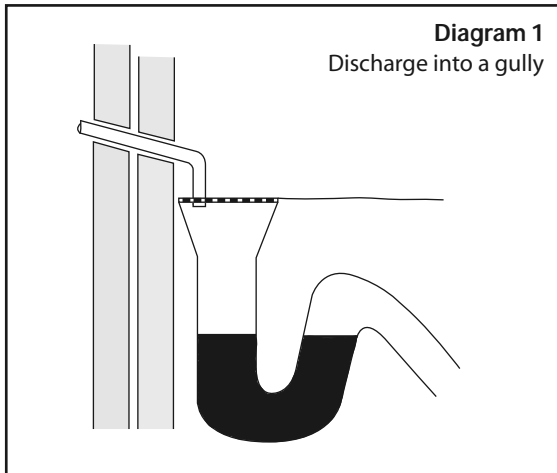

Figure 2.5

2.0 INSTALLATION

2.1 SITE REQUIREMENTS

The appliance is designed to be installed in an airing/cylinder cupboard and the relevant minimum dimensions are provided in section 1.2 Technical Data.

Because of the ease of installation we recommend that the cupboard construction is completed and painted before installation of the appliance. The cupboard door can be fitted after installation.

If the unit needs to be stored prior to installation it should be stored upright in a dry environment and on a level base/floor.

Installation and maintenance access is needed to the front of the appliance and above the F & E cistern. See section 1.2 Technical Data for further details.

The minimum dimensions contained in section 1.2 Technical Data allow for the passage/connection of pipes to the appliance from any direction as long as the appliance is installed on the installation base provided. If the installation base is not used extra space may be needed to allow connection to the pipework and the whole of the base area should be continuously supported on a material which will not easily deteriorate if exposed to moisture.

The floor of the cupboard needs to be level and even and capable of supporting the weight of the appliance when full. Details of the weight when full is provided in section 1.2 Technical Data.

The appliance is designed to operate as quietly as practicable. However, some noise (from pumps etc) is inevitable in any heating system. This will be most noticeable in cupboards formed on bulkheads, or at the mid span of a suspended floor. In these cases the situation can be improved by placing the appliance on a suitable sound deadening material (i.e. carpet underlay or similar).

The cylinder is very well insulated and no ventilation is normally required to the cupboard.

A suitable location will be needed for the separate feed and expansion cistern or expansion vessel. This will often be on top of the appliance itself or at high level in the cupboard housing the Accolade^{A-CLASS}. The dimensions and clearances are shown in section 1.2 Technical Data. The location will need to provide a suitable route for the cold feed/expansion pipe and safety/open vent pipe for the appliance with OV systems or the connecting pipe to the system expansion vessel with sealed primary systems. A suitable route and discharge position for the warning/overflow pipe and the ball valve supply from the mains cold water system will also be required with OV systems. A suitable route and discharge location will also be required for the discharge pipe from the P & T valve and ERV for all models.

An electrical supply must be available which is correctly earthed, polarized and in accordance with the latest edition of the IEE requirements for electrical installations BS 7671.

The electrical mains supply needs to be 230V/50Hz/1Ph

Connection must be made using a double-pole linked isolator with a contact separation of 3mm in both poles which is located within 1m of the appliance. The supply must only serve the appliance.

The supply to all models shall be fused at 30 amp.

2.2 INSTALLATION

Preparation/placing the appliance in position

Details of the recommended positions for termination of the first fix pipework are provided in section 1.2 Technical Data. The pipework can be located or its position checked using the template provided with each appliance. If these have been followed installation is very simple and much quicker than any other system. The appliance is supplied shrink wrapped on a timber installation base. Carrying handles are also provided in the back of the casing.

If the optional OV or SS kit is ordered this will be supplied in a separate box. **It is the installers responsibility to check that the size of cistern/expansion vessel provided is adequate for the primary/heating system being installed.** If flexible connections have been ordered these will also be inside the OV/SS kit box.

The appliance should be handled carefully to avoid damage and the recommended method is shown opposite. Further details are provided on page 2 of these instructions. Before installation the site requirements should be checked and confirmed as acceptable. The plastic cover and protective wrapping should be removed from the appliance and the installation base (provided) placed in position.

The appliance can be then be lifted into position in the cupboard on top of the base and the front panel removed by unscrewing the 2 screws and lifting the door up and out (see opposite) ready for connection of the pipework and electrical supplies. If they are not being fitted on top of the appliance a support shall be installed for the feed and expansion cistern/expansion vessel ensuring that the base is fully supported and the working head of the boiler/system is achieved. The recommended access for maintenance must also be provided - see section 1.2 Technical Data.

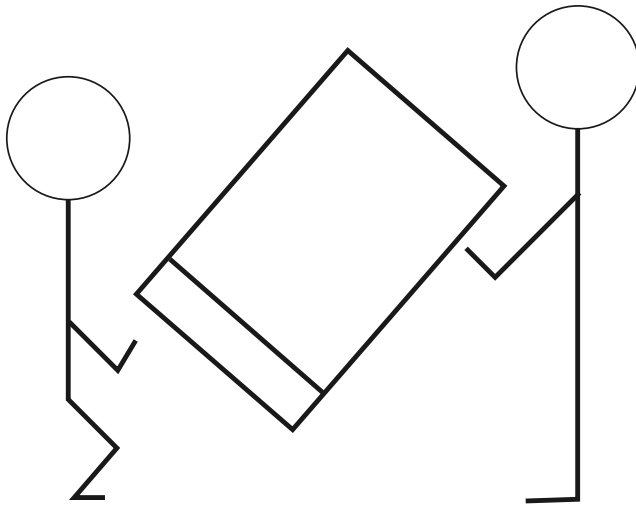

- When lifting the unit work with someone of similar build and height if possible
- Choose one person to call the signals
- Lift from the hips at the same time, then raise the unit to the desired level
- Move smoothly in unison
- Larger units may need team lift

2.0 INSTALLATION

2.2 INSTALLATION

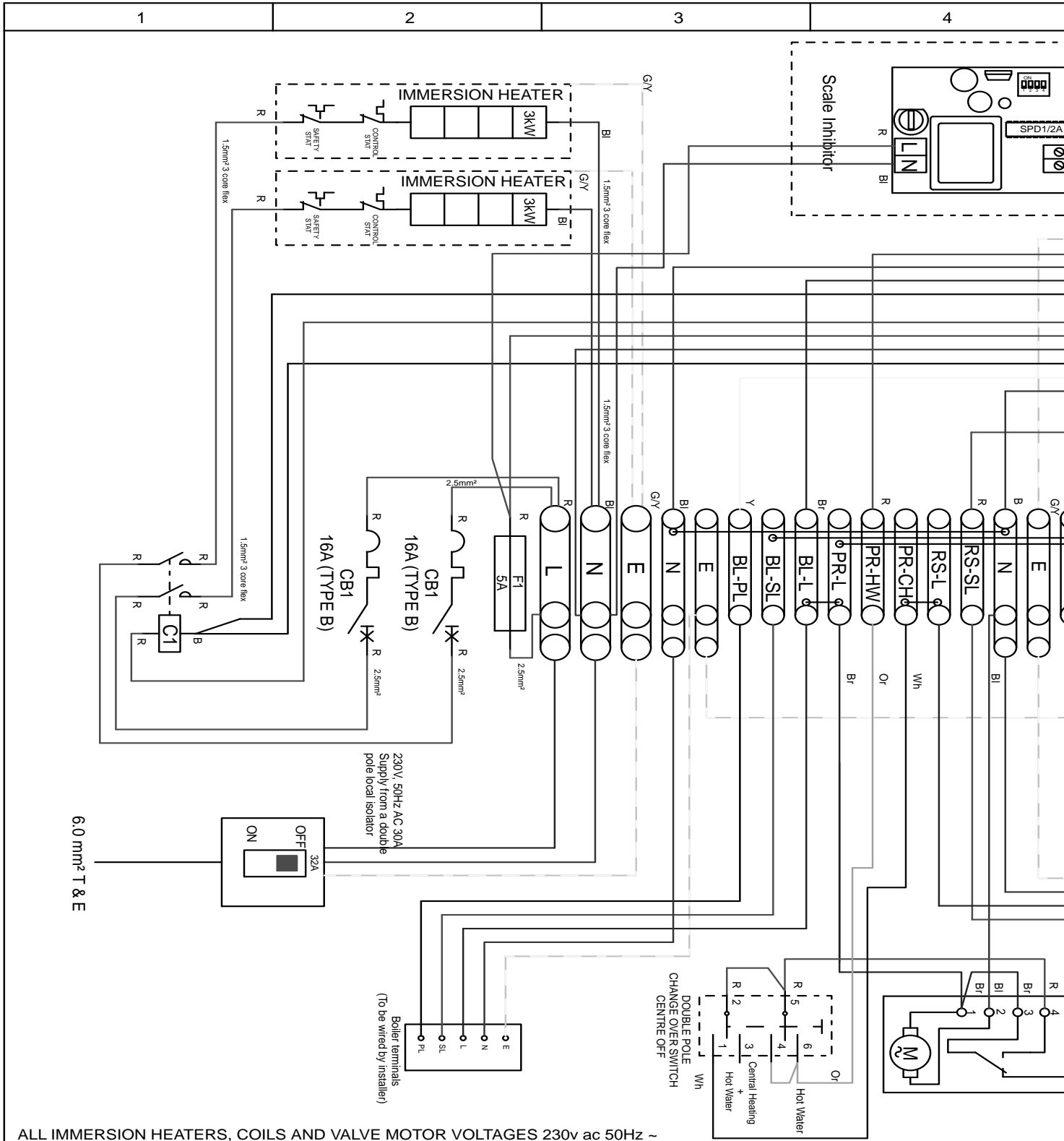

ALL IMMERSION HEATERS, COILS AND VALVE MOTOR VOLTAGES 230v ac 50Hz

DRN.
P. Ganderton

DATE
08-12-04

DATE : DECEMBER 2004

ISSUE No : 2

APPROVED

2.0 INSTALLATION

2.2 INSTALLATION

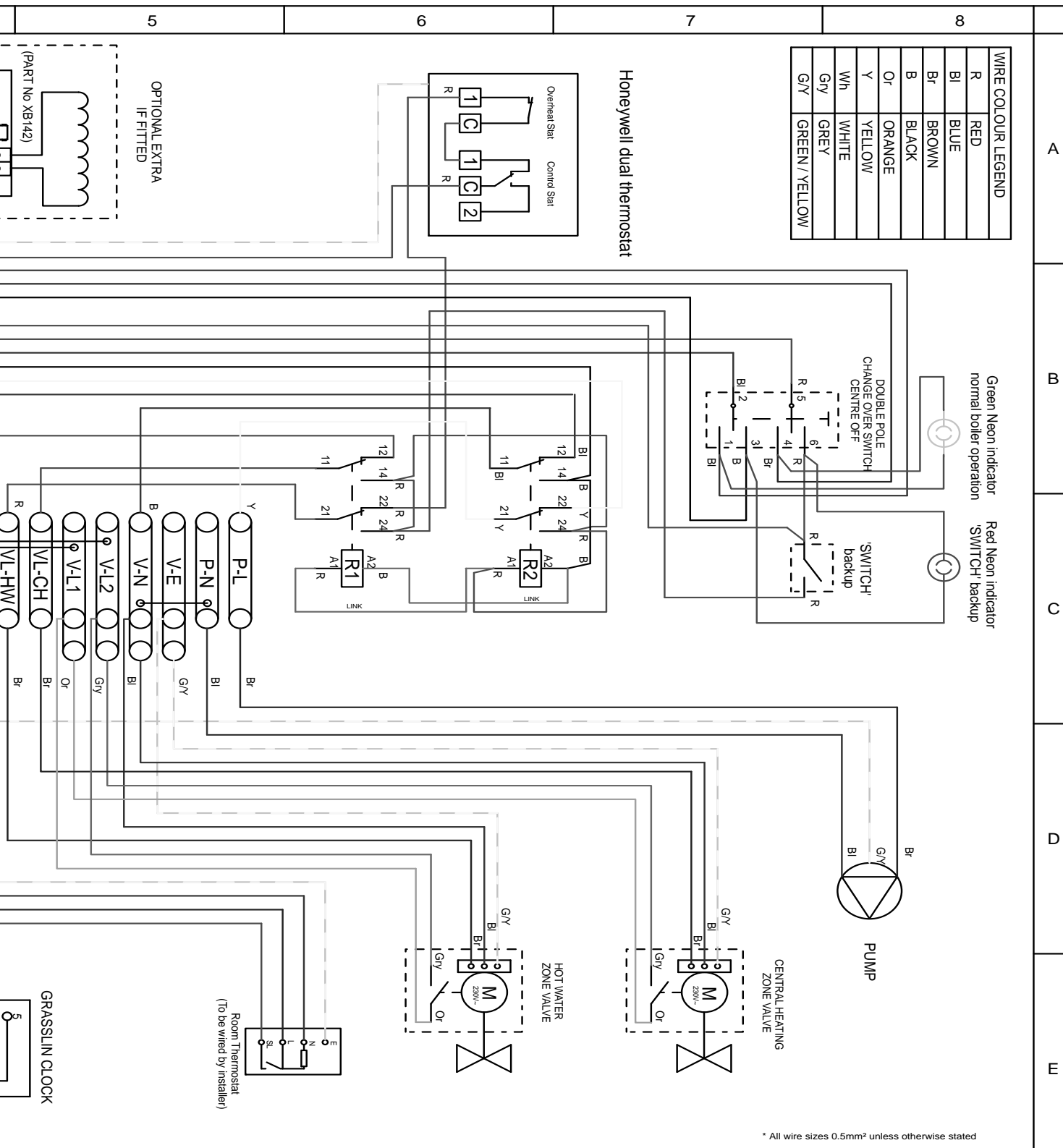

* All wire sizes 0.5mm² unless otherwise stated

H'KD. S. McGachie	APP'D. S. Gataora	DATE 09-12-04	TITLE ACCOLADE 'A' Class	JOB NAME Electrical Schematic for ACCOLADE 'A' class appliance with GRASSLIN clock (factory standard)
GLEDHILL WATER STORAGE LTD. SYCAMORE TRADING ESTATE SOIRES GATE LANE BLACKPOOL LANCASHIRE FY4 3RL				DRG. SIZE A3
DO NOT SCALE FROM THIS DRAWING. COPYRIGHT OF THIS DRAWING IS RESERVED. IT IS NOT TO BE REPRODUCED COPIED OR DISCLOSED TO A THIRD PARTY EITHER WHOLLY OR IN PART WITHOUT OUR WRITTEN CONSENT. © GLEDHILL WATER STORAGE LTD.				DRG. NAME A class Accolade.fc7
				REV. 0

2.0 INSTALLATION

2.2 INSTALLATION

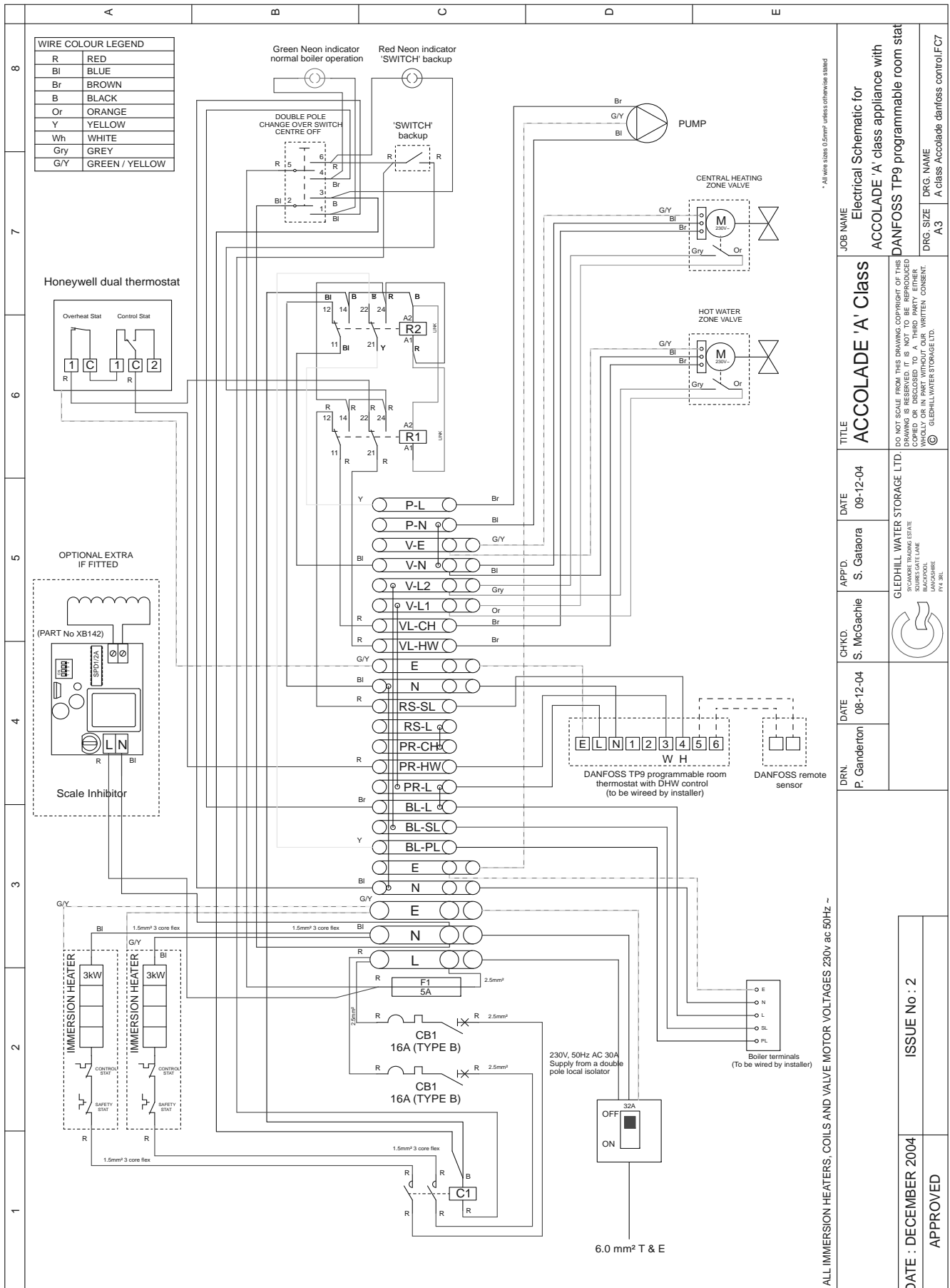

JOB NAME	Electrical Schematic for ACCOLADE 'A' class appliance with DANFOSS TP9 programmable room stat
TITLE	ACCOLADE 'A' Class
DATE	09-12-04
APPD.	S. Gataora
CHKD.	S. McGachie
DRN.	P. Ganderton
DATE	08-12-04
DRG. NAME	A class Accolade danfoss control.FCT
DRG. SIZE	A3
<p>DO NOT SCALE FROM THE DRAWING. COPYRIGHT OF THIS DRAWING IS RESERVED AND WILL BE WHOLLY OR IN PART WITHOUT OUR WRITTEN CONSENT. © GLEDHILL WATER STORAGE LTD.</p> <p>SCHEMATIC DRAWING LISTE 1. ACCOLADE 'A' CLASS APPLIANCE 2. DANFOSS TP9 PROGRAMMABLE ROOM STAT 3. DANFOSS REMOTE SENSOR 4. SCALE INHIBITOR 5. HONEYWELL DUAL THERMOSTAT 6. IMMERISION HEATERS 7. PUMP 8. ZONE VALVES</p>	
ISSUE No :	2
DATE :	DECEMBER 2004
APPROVED	

2.0 INSTALLATION

2.2 INSTALLATION

Pipework connections

The position of the pipework connections is shown opposite. The connection sizes and dimensions are listed in Section 1.2 Technical Data.

All the connections are also labelled on the appliance. It is essential that the pipework is connected to the correct connection.

The connections can be hard piped but we recommend the use of flexible connections (available as an optional extra).

When using the push fit connectors with the flexible hose kits it is important to check that they are compatible. Written approval has already been obtained for :-

Hepworth - Hep:O BiTite
John Guest - Speedfit
Yorkshire - Tectite

However, as similar assurances cannot be obtained for Polypipe fittings we cannot recommend their use at this time.

Connections :-

- A. Primary flow (from boiler)
- B. Primary return (to boiler)
- C. Central heating flow
- D. Central heating return
- E. Drain assembly
- F. Incoming mains water
- G. Balanced pressure cold outlet
- H. Domestic hot water
- I. Discharge from the ERV
- J. Discharge from the P & T valve

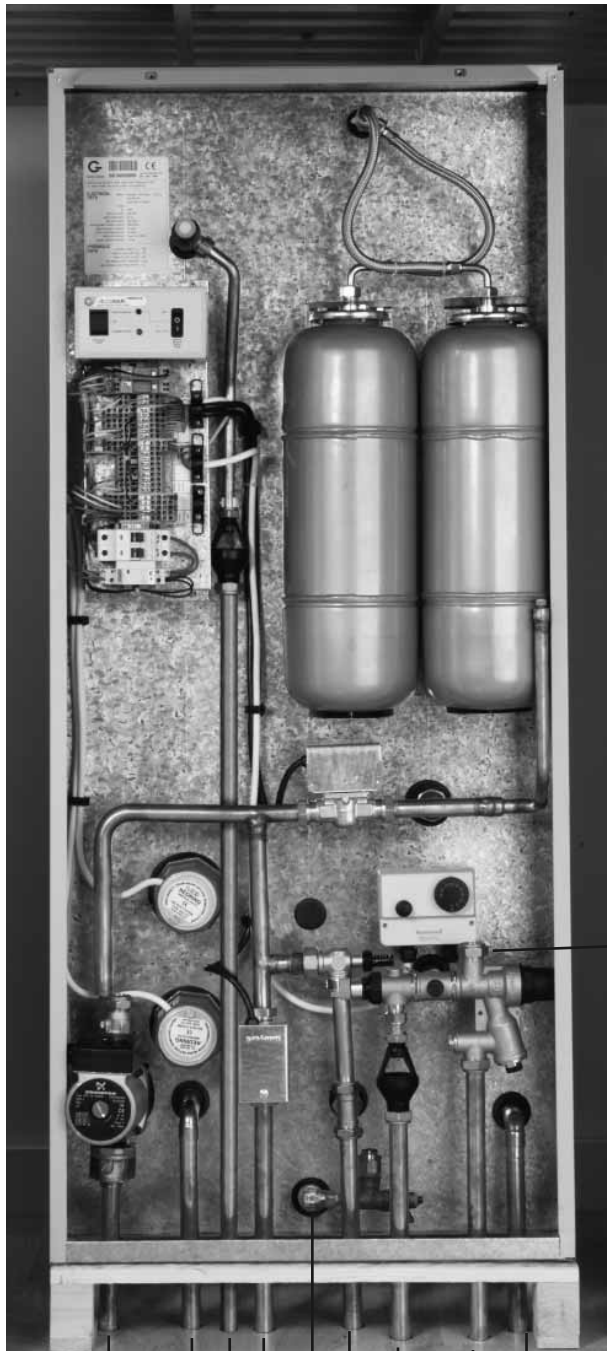

A B J C E D I F H

Ensure the discharge pipes from the P & T valve and ERV are laid to a continuous fall and that there is at least 300mm of vertical pipework below the tundish before any bends.

2.0 INSTALLATION

2.2 INSTALLATION

All factory made joints should be checked after installation in case they have been loosened during transit.

OV Systems

The fittings for the feed and expansion cistern should be installed and the cistern fitted on top of the appliance/on supports (not provided) at high level in the cupboard or in the roof space.

If it is necessary to locate the cistern in the roof space any pipework in the roof space and the feed and expansion cistern will need to be adequately insulated to protect against frost damage.

The 22mm safety/open vent shall rise continuously from the boiler and terminate in the F & E Cistern.

No valves should be fitted in the safety open vent which must be a minimum of 22mm copper pipe or equivalent.

The overflow/warning pipe shall have a continuous fall, be fitted to discharge clear of the building and be sited so that any overflow can be easily observed. It shall also be installed in a size and material suitable for use with heating feed and expansion cisterns in accordance with BS 5449 and should not have any other connections to it.

SS Systems

The expansion vessel should be fitted on top of the appliance or on the supports provided and connected to the appliance using a manual air vent at the high point.

It is normally envisaged that the expansion vessel will be located in the same cupboard as the Accolade^{A-CLASS} appliance.

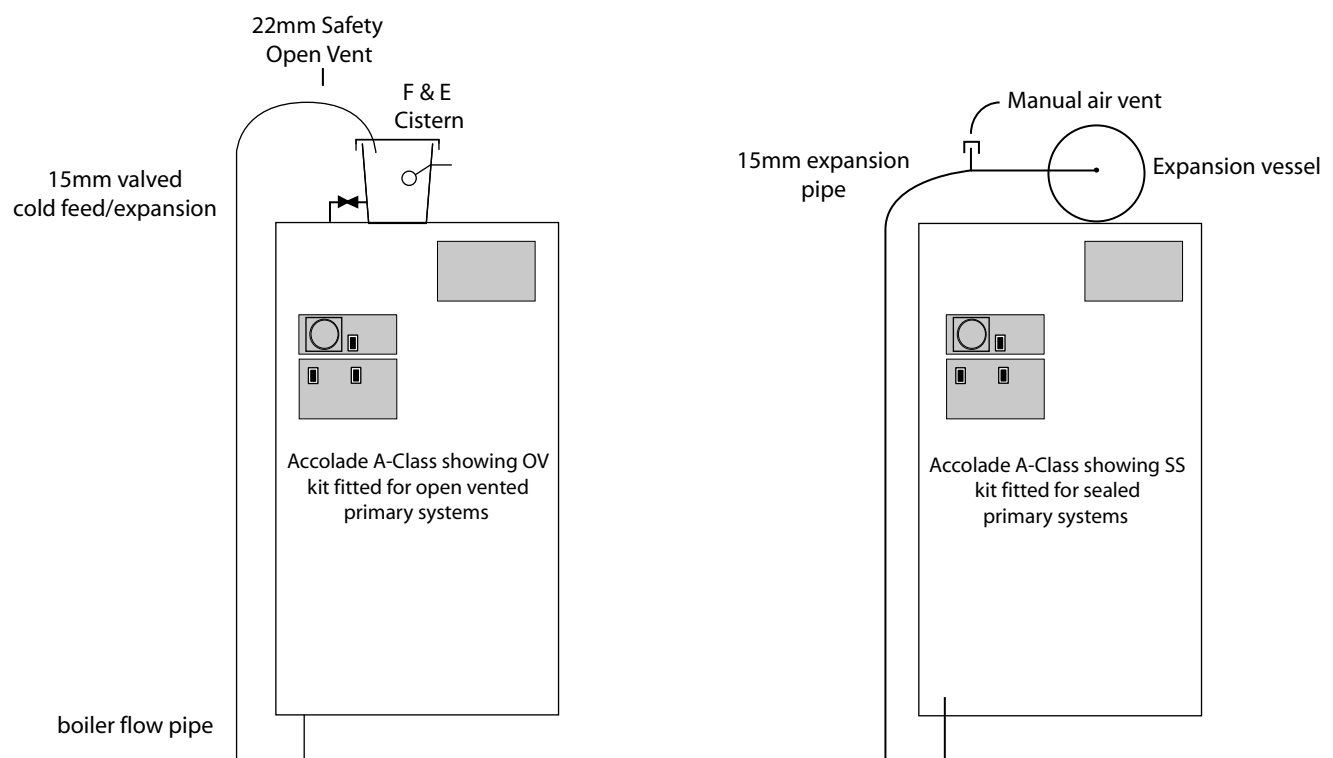

2.2 INSTALLATION

Electrical Connection - Appliance

The boiler and control functions of the Accolade A-CLASS are pre-wired to a 25 way terminal strip. The wiring to the appliance shall be carried out by a competent person in accordance with the Building Regulations (Approved Document P) and the IEE Requirements for Electrical Installations BS 7671. A schematic arrangement of the wiring is shown opposite.

Terminals 1 - 15 should be wired on site in accordance with the diagram opposite. Terminals 16 - 25 are pre-wired to components fitted on the appliance.

All the terminals are suitably labelled on the appliance.

Note: Do not attempt the electrical work unless you are competent to carry it out to the above standards.

Before commencing check that the power source is in accordance with section 1.2 Site Requirements and ensure that it is isolated.

The boiler manufacturers wiring instructions should be read in conjunction with this manual.

Run the external wiring through the service slot provided in the base of the appliance.

Make the connections as shown opposite on the terminal strip provided.

If the boiler does not provide a pump live connection a link should be placed between terminals 6 and 7 (BL-PL and BL-SL).

The appliance is provided with a link between terminals 12 and 13 on the terminal strip. This must be removed when the room thermostat is fitted.

Before switching on the electrical supply check all the factory made terminal connections to ensure they have not become loose during transit.

Frost Protection

When frost protection is required for the whole house set the programmer to constant during the time required and adjust the room thermostat to a suitable setting.

If frost protection is required only to protect parts of the system installed in unheated areas frost thermostat(s) must be fitted.

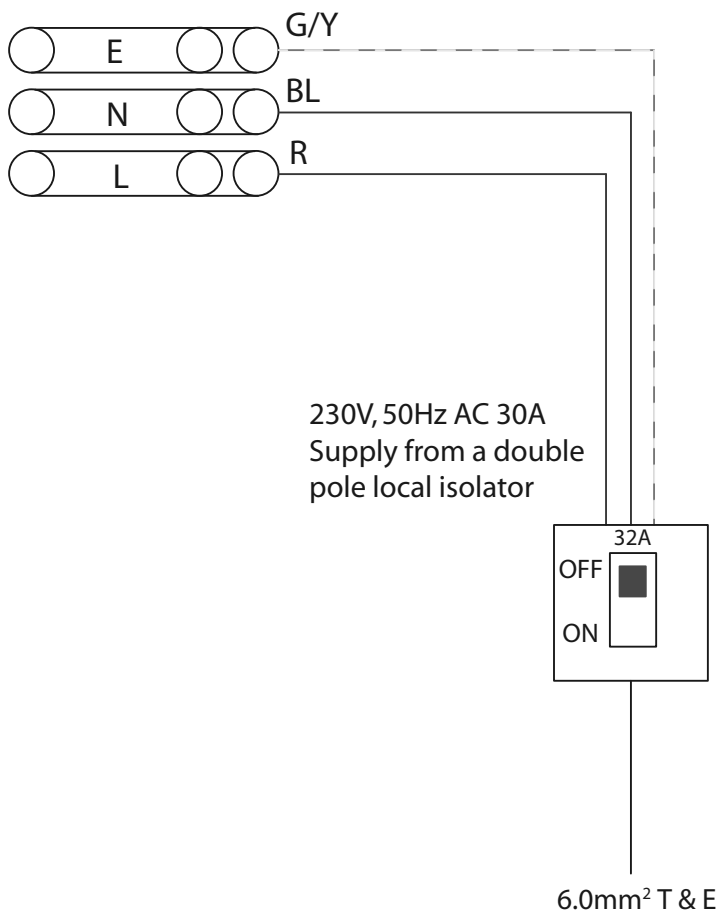

2.0 INSTALLATION

2.3 COMMISSIONING

SYSTEM FILLING/CLEANSING

Check and adjust as necessary the hot water system expansion vessel(s) air pressure to 1.5 bar.

Check that any drain valves are closed then open the incoming stop valve and fill the domestic mains cold and hot water systems in the normal way ensuring there is no air trapped in the system.

In the case of OV systems fill the heating system with potable water through the feed and expansion cistern flush and refill. Check the water level in the feed and expansion cistern and adjust the ballvalve if necessary. Check the warning pipe is installed correctly, has a continuous fall and is not blocked i.e. discharges water freely.

In the case of SP systems check and adjust as necessary the primary heating system expansion vessel to the figure specified (normally 1.0 bar)

Note: The expansion vessel pressures should be checked before the systems are filled. Fill the primary heating system with potable water through the filling loop provided adjacent to the boiler to the pressure required (normally 1.0 bar).

During filling vent air as necessary from the high points of the system including the manual air vents provided on the appliance and on the feed to the expansion vessel.

Check the whole of the primary heating and domestic hot and cold distribution systems for leaks.

It is essential that all systems functions properly for optimum performance.

To achieve this, the primary system should be commissioned in accordance with good practice and generally in accordance with the requirements of BS 6798, BS 5449 and BS 7593.

Full details of the requirements are given in PAS 33:1999 under Section 10 Commissioning.

When using either cleansing or corrosion inhibitor chemical, the manufacturers instructions must be followed.

Cleansing the Primary System

It is very important to ensure that the Primary system is cleaned using a suitable cleansing agent such as Sentinel X300 or Fernox Superfloc to ensure that any flux residues/installation debris are removed.

The volumes/concentration should be calculated in accordance with the manufacturers instructions allowing the volume for the primary coil shown in the Table in 1.2 Technical Data.

Primary Water System Treatment

Although the Accolade^{A-CLASS} has no special water treatment requirements, the radiators and other parts of the circuit will require the application of a scale and corrosion inhibitor such as Sentinel X100 or a Protector such as Fernox MB1.

The volumes/concentration should be calculated in accordance with the manufacturers instructions allowing the volume for the primary coil shown in the Table in 1.2 Technical Data.

POWERFLUSHING/CLEANING OF THE HEATING SYSTEM

If it is proposed to 'powerflush' the heating system always check and comply fully with the manufacturers instructions for the powerflushing equipment being used.

If in any doubt please consult our Technical Helpline.

Cleansing the Hot/Cold Water System

Fully flush and, when necessary, chlorinate the hot and cold water system in accordance with the recommendations in the Model Water Byelaws and BS 6700.

Remove and clean the strainer element in the combination inlet valve, then replace it and re-fill the systems.

Once the systems have been refilled manually open the relief valves one by one and check that water is discharged and runs freely through the tundish and out at the discharge point. The pipework should accept full bore discharge without overflowing at the tundish, and the valve should seat satisfactorily.

With OV systems once the system is finally filled turn down the servicing valve for the ballvalve in the F & E Cistern to the point where the warning/overflow will cope with the discharge arising from a ballvalve failure.

With SP systems check the pressure and disconnect the manual filling loop.

2.3 COMMISSIONING

Appliance Commissioning

Check the temperature setting on the control thermostat is set at 60°C. Turn on and check that thermostats and all controls operate correctly as well as any motorised valves. Check that no water discharges from either the expansion valve or temperature and pressure-relief valve during the heating cycle. Check the temperature setting on the switch immersion heater thermostats are set at 60°C. Turn on and check they operate and switch off at the correct temperature.

Check the appliance, the heating system and hot water system for leaks when hot.

System Commissioning

Check that the correct outlet pressure is being maintained on the domestic water systems by the pressure reducing valve by checking the pressure at a hot tap or in the tapping provided on the combination inlet valve.

Check the correct flow is being achieved at each tap and the implications of opening more than one tap at the same time. If necessary fit flow regulators to each tap.

The heating system is set to operate as a standard 'S' plan and the pump and primary system should be set and balanced in the normal way to provide a temperature differential of 11°C.

An automatic bypass valve is provided on the primary/heating circuit. This is factory set to 2m head but may need to be adjusted to suit the particular installation requirements.

The room thermostat/programmer or programmable room thermostat controls the heating and hot water systems separately and should be set to suit the householders requirements using the instructions provided with the controls.

This product is covered by the 'Benchmark' scheme and a separate commissioning/service log book is included with this product. This must be completed during commissioning and left with the product to meet the Warranty conditions offered by Gledhill.

On completion:-

1. Do ensure that the electrical connections (e.g. mains supply, room thermostat) to the unit are correct and tight.
2. Do ensure that all the pipework connections in the appliance are tight and not leaking.
3. Do ensure that any pipework particularly plastic adjacent to the appliance is adequately supported and anchored.
4. Do ensure that the functioning and control of the system is explained to the occupant and explain the need and importance of periodic servicing.

These Instructions should be placed along with the component manufacturers instructions in the pocket provided on the rear of the front panel. The front panel should then be refitted.

NOTE:- With sealed heating systems air is released from the water during the first few weeks of operation. This must be vented and the system repressurized.

2.0 INSTALLATION

2.3 COMMISSIONING

If the system is not likely to be used continuously after testing/commissioning it should be isolated from the water and electricity supply and either drained down or have the pressure removed from both the heating and water systems.

Important Do's and Don'ts

DO check the incoming mains water pressure and flow rate are adequate. (The preferred range of mains pressure is 2.5-3.5bar).

DO check and ensure that the air pressure side of the hot water expansion vessel(s) is set at 1.5 bar.

DO check that all plumbing and electrical connections are in accordance with the labelling on the unvented storage appliance.

DO insulate any exposed pipework in the Accolade^{A-CLASS} cupboard.

DO plumb the overflow/warning pipe (if fitted) in a 20mm internal diameter pipe material which is suitable for use with a heating F & E cistern, in accordance with BS 5449 (such as copper) and ensure it has a continuous fall and discharges in a conspicuous external position.

DO check the pump setting to give a temperature difference across the flow and return of not more than 11°C.

DO ensure that the bypass valve is set correctly.

DON'T use pipe smaller than 28mm between the boiler and the Accolade^{A-CLASS} when the boiler rating exceeds 20kW (about 68,000 Btu/h).

DON'T operate any immersion heaters until the appliance/systems are fully filled, vented and commissioned.

DON'T place any clothing or other combustible materials against or on top of this appliance

DO ensure the boiler is suitable (i.e. fitted with an overheat thermostat)

DO ensure that the discharge pipework from the relief valves is/are installed to a fall and are of the correct size so that water does not overflow when a relief valve operates.

DO ensure the discharge point is safe and in accordance with the G3 Building Regulations.

SS Systems

DO check and ensure the air pressure side of the heating expansion vessel is set at 1.0 bar (or as specified)

OV Systems

DO adjust the ballvalve so that the water level in the appliance F & E cistern when the system is cold is correct and does not overflow when the appliance is at maximum temperature

DO turn down the servicing valve for the ballvalve in the F & E cistern, once the system is finally filled, to the point where the warning/overflow pipe will cope with the discharge arising from a ballvalve failure.

DO make sure that there is adequate clearance above the appliance F & E cistern to service the ballvalve.

3.0 SERVICING

3.1 ANNUAL SERVICING

1	With the water supply turned off, remove the screen from the strainer in the combination inlet valve and clean off any detritus (dirt).
2	With the water supply turned off and the hot taps open, check the expansion vessel charge pressure and top up as necessary (1.5bar).
3	With the water supply turned on, open the temperature relief valve and then expansion valve to check for unrestricted discharge into tundish. Check valves for freedom of movement and confirm that the water stops and both valves reseal correctly. Check at a full bore discharge from either valve that there is no back up or discharges over the tundish.
4	Check that the correct outlet pressure is being maintained by the pressure reducing valve by recording the pressure at a terminal fitting or the tapping provided on the combination inlet valve.
5	Clean flow regulators (or restrictor/aerators) on each terminal fitting tap/shower as applicable. Check for correct flow rate at terminal fittings.
6	Visually inspect, checking for the presence of supplementary bonding and that it is being maintained.
7	Check correct rating and type of fuse is fitted on the electrical supply.
8	Check for the correct operation and temperature setting of the thermostats.
9	Check the operation of the motorised valves.
10	Check the operation of 'Switch'.
11	If necessary descale the heat exchangers immersion heaters in hard water areas.

SERVICING/MAINTENANCE

The Registered Installer is responsible for the safe installation and operation of the system. He must also make his customer aware that periodic checks of the equipment are required by the Building Regulations and essential for safety.

Maintenance and inspection periods will vary for many reasons. Gledhill Water Storage Ltd recommend a maximum of 12 months between inspections to coincide with boiler maintenance. Experience of local water conditions may indicate that more frequent inspection is desirable, eg. when water is particularly hard, scale-forming or where the water supply contains a high proportion of solids, eg. sand. For Maintenance see the table above:

The above service / maintenance recommendations relate to the Accolade^{A-CLASS} unit only. Any service of the boiler/heating system should include checks on the ballvalve/water level in the F & E cistern in OV systems or the air pressure in the primary expansion vessel with the system pressure removed in SP systems.

3.2 CHANGING COMPONENTS

If it is necessary at any time to drain the storage vessel either for system modifications or to replace a component the appliance should be drained in the following way.

Before draining open all hot taps in the system then hold open the pressure and temperature relief valve until water stops discharging into the tundish.

Open the ball-o-fix isolation valve just before the anti-vacuum valve and then open the drain cock and **immediately hold open the P & T relief valve again. This must be held open until the cylinder is completely drained.**

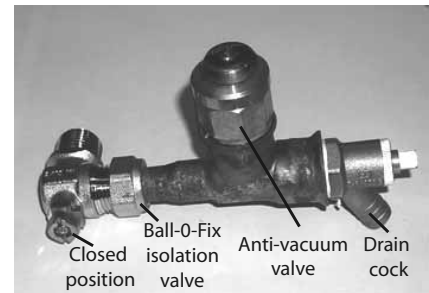

When the unit is re-filled ensure the ball-o-fix is left in the closed position as well as the drain valve.

The KIWA Approvals for the Accolade^{A-CLASS} appliance are conditional on the specific manufacturer/type of components fitted and any replacements must be purchased direct from Gledhill to ensure compatibility/continued safe operation.

Free of charge replacements for any faulty components are available from Gledhill during the in-warranty period (normally 12 months).

However, if any component is damaged during installation a new replacement must be ordered and paid for.

After this, spares should be obtained direct from Gledhill using the 'Speed Spares' service, or through any of the larger plumbers merchants/specialist heating spares suppliers.

Help and advice is also available from the Technical Helpline on 08449 310000.

However, all components are readily accessible and can be changed quickly and easily by the installer using common plumbing practice.

If it is necessary to replace any of the pumps fitted to the appliance the pump head (motor pack) only should be removed as recommended by Grundfos. Pumps should be replaced with a new pump obtained from Gledhill Water Storage. If this is within warranty it will be supplied free of charge. It is important when a pump has been replaced to ensure that any air is adequately vented.

3.0 SERVICING

3.3 SHORT PARTS LIST

Key No.	Description	Manufacturer	Stock Code No.	Gas Council Part No.
1	Inlet Control Group ICS	Honeywell	XG170	
2	P & T Valve TP152 4.0 bar and 95°C	Honeywell	XG169	
3	Tundish	Altecnic	XG173	
4	Control/Over Heat Thermostat	Honeywell Dualstat	XG168	
5	Hot Water/Heating Zone Valve 22mm V4043 with removable head	Honeywell	XG083	
6	Hot Water/Heating Zone Valve 28mm V4303 with removable head	Honeywell	XC012	
7	Automatic By-pass Valve	Comap	XG156	
8	Anti Vacuum Valve	Reliance	GT056	
9	Hot Water Expansion Vessel	CIMM	XG174	
10	Pump UPS 15-50 (22mm connections)	Grundfos	XB004	
11	Pump UPS 15-60 (28mm connections)	Grundfos	XB241	
12	Pump Valve 22mm	Vemco	XB121	
13	Pump Valve 28mm	Vemco	XB122	
14	Immersion Heater	Redring	XG086	
15	Primary Expansion Vessel	Varem		
16	Primary Expansion Relief Valve and Pressure Gauge	Comap	XG154	
17	Relays Wago			
18	Relays Telemecanique	XB014	XB014	

3.3 SHORT PARTS LIST

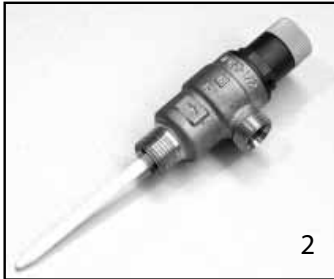

3.0 SERVICING

3.4 FAULT FINDING

SCALE

In accordance with the Benchmark Guidance Notes in hard water areas, above 200ppm (mg/l) it is recommended that an in-line scale reduction device is fitted. Reducing the temperature of the stored water will reduce the rate at which scale forms but must not be reduced to less than 60°C. If the recovery rate is badly affected, this is an indication that scaling may have occurred. In this event, follow the procedures as recommended by a reputable Water Treatment Company.

GENERAL

All work must be carried out by a suitably qualified/competent person.

No/Reduced flow of hot water at the taps

Check that the mains water supply is turned ON. Check the line strainer in the combination inlet valve is not blocked. Check that the combination valve has been fitted so that water is flowing in the correct direction.

If the water at the tap is cold

Ensure that the boiler has been switched ON and is working correctly. Check that there are no air locks in the primary system. ISOLATE THE UNIT AT THE MAINS ELECTRIC SUPPLIES AND THEN CHECK THE FOLLOWING:-

- i) The control thermostat
- ii) The overheat thermostat, which can be re-set by unscrewing the black cover and pushing the red button.
- iii) The motorised valve
- iv) The boiler thermostat
- v) The boiler overheat thermostat
- vi) Programmer with the indirect appliance

If the boiler is for any reason unable to supply heat to the appliance heating and/or hot water can be obtained by operating the 'Switch' controls on the front of the appliance.

ANY ENERGY CUT-OUT MUST NEVER BE BY-PASSED UNDER ANY CIRCUMSTANCES.

If the unit is still getting hot, ensure that the immersion heater is isolated from the mains before re-setting the energy cut-out. If the immersion heater(s) need replacing this should be done with the unit supplied from Gledhill Water Storage Ltd. Same day despatch to approved installers can be arranged by telephoning 01253 474444.

DISCHARGE FROM RELIEF VALVES

If cold water is discharging from the expansion relief valve drop the system pressure and check the air pressure in the expansion vessel is 1.5 bar.

If the fault continues and the problem cannot be stopped by operating the easing control a few times then either the Pressure Reducing Valve or the Relief Valve may be at fault. If the cold water pressure is too high, this would suggest that the Pressure Reducing Valve is at fault and the Gledhill approved replacement should be fitted. If the pressure is correct then the Relief Valve/cartridge will require replacing with a Gledhill approved component.

If there is an overheat fault and very hot water is being discharged, turn off the heat source, but not the water supply. When the system is cool, check the control and overheat thermostats and energy cut-outs in the immersion heater and replace the faulty component with a unit supplied by Gledhill and check that it works correctly before returning the system to full operation.

WATER SAVINGS

WATER RELATED COSTS CAN BE REDUCED BY GOOD PLUMBING PRACTICE.

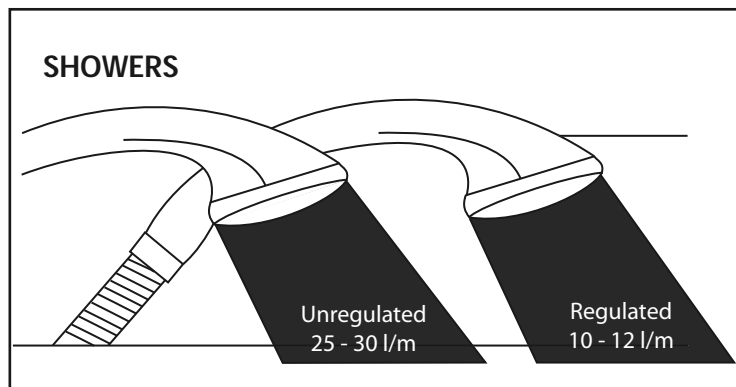
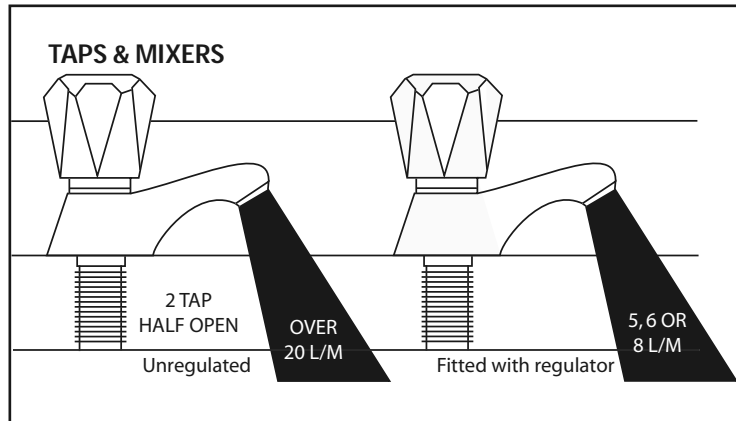

Vast quantities of water are needlessly run off to waste due to Taps, Mixers and Showers discharging flow rates far in excess of the rates required for them to perform their duties.

The contrasting flow rates shown on this leaflet clearly illustrate the savings that can be made whilst still providing a good performance.

British made Aquaflow Regulators provide constant flow rates by automatically compensating for supply pressure changes between 1 bar & 10 bars.

To facilitate installation into the wide range of plumbing equipment which is encountered in the U.K, Four Fixing Options are available:-

OPTIONS FOR SHOWERS

1. MXF "DW" Range - For fitting behind Fixed Shower Heads or onto Flexible Hoses for Handshowers (preferably onto the inlet end when lightweight hoses are used).
2. Compression Fitting Range. "In Line" regulators as in Option 4 for Taps & Mixers.

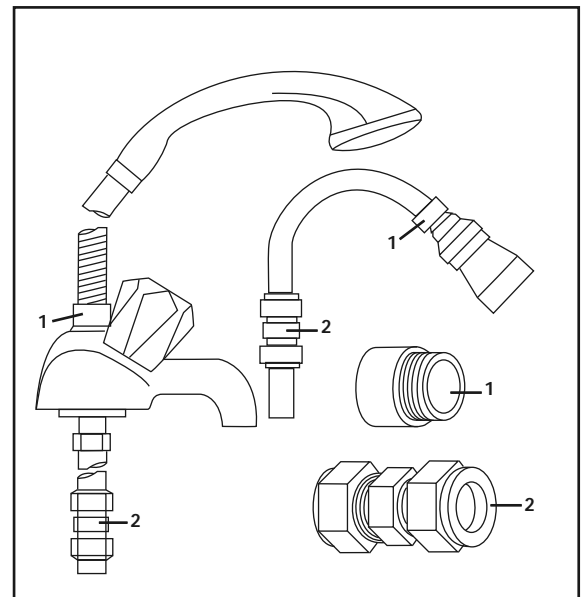

4 FIXING OPTIONS FOR TAPS & MIXERS

1. MK Range - Combined Regulators & Aerator for screwing onto Taps & Mixers with internal or external threads on their noses. Anti Vandal models also available.
2. MR05-T Range - Internal Regulators. Push-fit into Tap or Mixer seats. Produced in three sizes - 12.5mm (BS1010), 12mm & 10mm, Flangeless models also available for Taps with Low Lift washers.
3. MXF Standard Range - Screw on tail models for Taps & Mixers. Fix onto the tails before fitting the tap connectors. Available in 3/8", 1/2", 3/4" and 1" BSP.
4. Compression Fitting Range - "In Line" regulators housed in 15mm & 22mm CXC Couplers & Isolating Valves. "UK WFB S" listed by the Water Research Centre. Isolation valves available for slotted screwdriver operation or with coloured plastic handles. Now available also in plastic bodied push-fit couplers & valves.

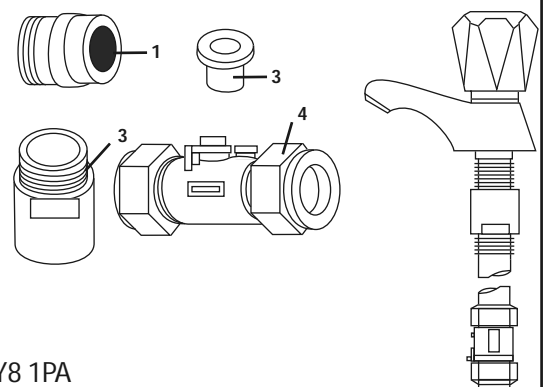

Information by courtesy of

AQUAFLOW REGULATORS LTD

Haywood House, 40 New Road, Stourbridge, West Midlands DY8 1PA
TELEPHONE (01384) 442611 FAX: (01384) 442612

APPENDIX B

MANIFOLDS

Manifold type: 1 - Stock Code MIP 050 (one bathroom, one en suite shower room, one cloakroom, one kitchen)			
Flow regulator (litres/minutes)	Terminal fitting	Hot water manifold outlets Quantity	Cold water manifold outlets Quantity
18	Bath tap	1	1
9	Hand basin	3	3
12	Kitchen sink	1	1
9	Toilet cistern	None	3
9	Shower	1	1
12	Washing machine	1	1
9	Dishwasher	None	1
	Total	7	11

Two sets of manifolds are available as an optional extra. Each set comprises a separate hot and cold water manifold. Both are provided with a 22mm inlet connection located centrally. All outlet connections are 15mm compression. The centre to centre dimension of each branch is 55mm.

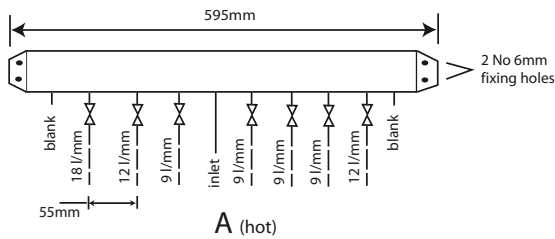

A (hot)

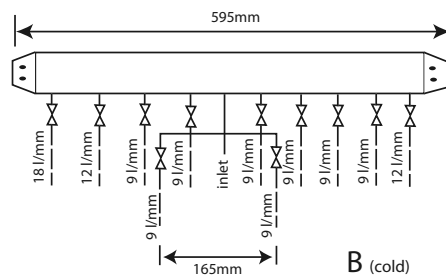

B (cold)

Manifold type: 2 - Stock Code MIP 060 (two bathrooms, one en suite shower room, one cloakroom, one kitchen, one utility room)			
Flow regulator (litres/minutes)	Terminal fitting	Hot water manifold outlets Quantity	Cold water manifold outlets Quantity
18	Bath tap	2	2
9	Hand basin	4	4
12	Kitchen sink	2	2
9	Toilet cistern	None	4
9	Shower	1	1
12	Washing machine	1	1
9	Dishwasher	None	1
	Total	10	15

The arrangement of each manifold is supplied as shown. This provides the best balance of flows but the flow regulators/duty of each branch can be changed if required as long as a reasonable balance is maintained. If it is necessary to change or clean the flow regulator this can be done without needing to drain the system by closing the valve and removing the screwed cover below the white plastic cover.

The manifolds are designed to be used with plastic pipework and are supplied complete with isolation valves and flow regulators on each branch. They would normally be installed in the same cupboard as the thermal storage appliance (as shown below) but can be installed in another cupboard close to the appliance if required.

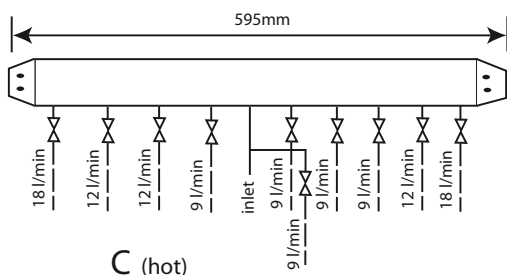

C (hot)

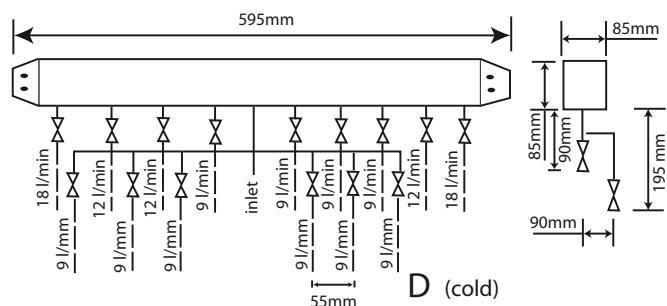

D (cold)

APPENDIX B

An optional location where cupboard space is tight



The pressure loss through a flow regulator at the designated flow rate is about 1.8 bar. Therefore for the flow regulator to control the flow rate at pre-set level, the inlet pressure must be greater than 1.8 bar. If the inlet pressure is lower, the flow rate will be correspondingly less than the pre-set values.

The maximum equivalent pipe lengths from the manifold to the terminal fittings can be estimated from the above information and the resistance characteristics of the pipes. The examples presented below are for 15mm copper pipe in table 1 and for plastic pipework in table 2.

The preferred solution where space will allow



Table 1: Maximum equivalent pipe length in 15mm copper			
Inlet pressure (bar)	Maximum equivalent length of pipe (m)		
	@ 9 l/m	@ 12 l/m	@ 18 l/m
2.0	25	10	5
2.5	75	30	15
3.0	150	60	30

Table 2: Maximum equivalent pipe length in plastic pipe			
Inlet pressure (bar)	Maximum equivalent length of pipe (m)		
	@ 9 l/m	@ 12 l/m	@ 18 l/m
2.0	1.5	15mm : 10	15mm : 4.5 22mm : 40
2.5	3.0	15mm : 20	15mm : 9.0 22mm : 80.0
3.0	4.5	15mm : 30	15mm : 13.5 22mm : 120

APPENDIX B

The size of the distribution pipes supplying the manifold should be calculated using the method set out in BS 6700. A typical diagrammatic arrangement of a system using Manifold Type 1 is shown below. This is only meant to show the principles involved and the actual connection of fittings to the manifold will need to suit the arrangements shown on page 35.

Note 1 - If it is proposed to fit chemical water treatment such as a water softener this should be fitted in this location and the cold water branch in the sink should be branched off the cold water main prior to the treatment device instead of the cold water manifold.

Any other isolating/control valves and backflow protection devices should be provided as necessary to comply with the Water Regulations.

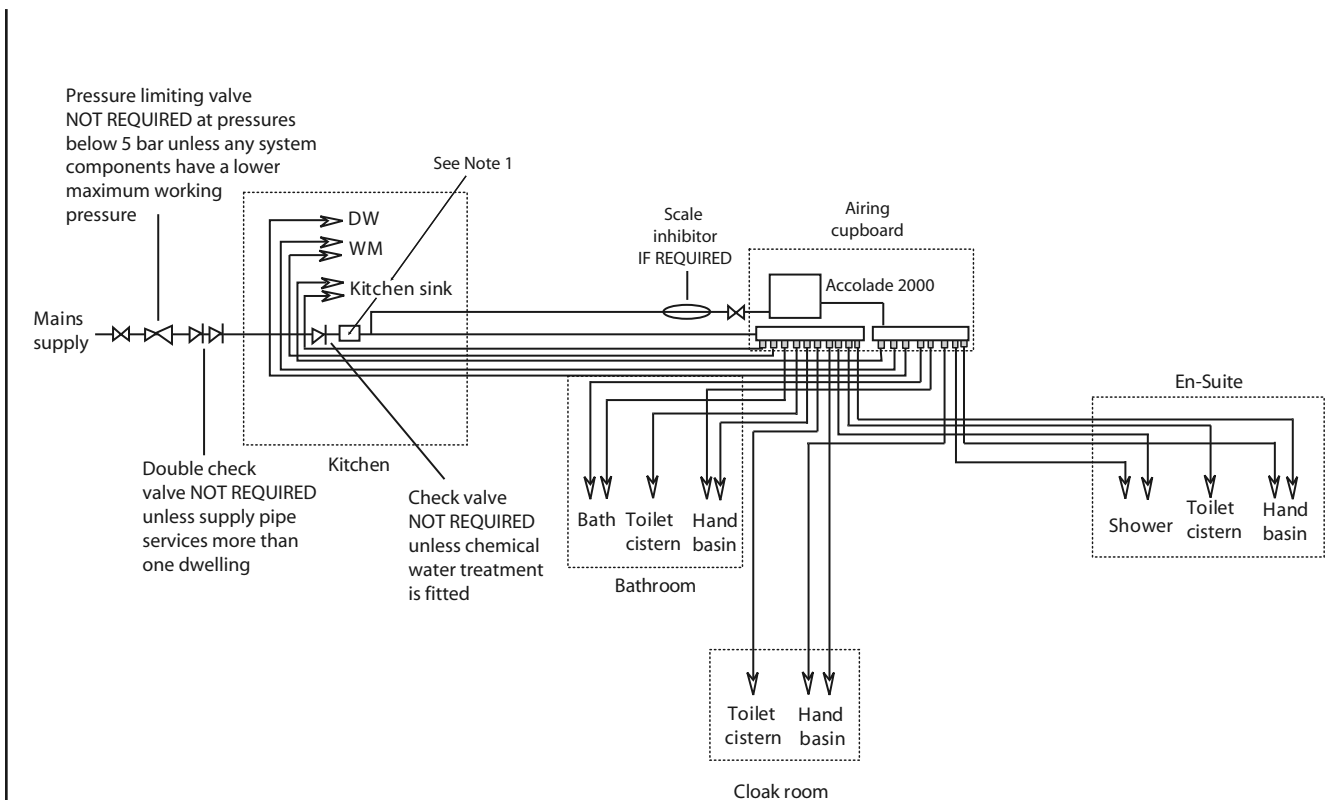



2 Inhibitor (Corrosion & scale protection of primary heating circuit)

On filling the heating system and before the boiler is fired up, it is important to ensure the system water is treated with a suitable corrosion inhibitor, in accordance with the boiler manufacturer's instructions.

Since the concentration of inhibitor present in a system can become diluted, for a number of different reasons, the system should be checked annually and re-treated as required, or after every full or partial drain-down. A water treatment manufacturer's test kit may be used to check the correct concentration of inhibitor in the system.

Where recommended by a boiler manufacturer, a 'physical corrosion protection device' may be fitted in the primary pipework in accordance with the boiler manufacturer's instructions.

The Benchmark log book should be completed indicating the date and details of any of the above products added and a permanent label should be fixed to the system in a prominent location.







3 Scale protection (Domestic hot water service)

Where a combi boiler and/or a hot water storage vessel is installed in areas where the mains water can exceed 200ppm Total Hardness (as defined by BS 7593: 1993 Table 2) a scale reduction device should be installed, in accordance with the boiler manufacturer's instructions. The levels of water hardness may be measured using a water hardness test kit.

BUILDING REGULATIONS

Completion of the BENCHMARK log book requires that the 'competent person' undertaking the installation and commissioning provide information relating to Cleaning, Inhibitor and Scale Protection. This will demonstrate that the work complies with the requirements of the appropriate Building Regulations.

This Guidance Note is produced on behalf of its members by the Central Heating Information Council. For a full list of members visit www.centralheating.co.uk and for further advice on water treatment contact the following members:

 Culligan  Sentinel  Ferno  Salamander Engineering  Scalemaster

Heating & Hotwater Information Council, 36 Holly Walk, Leamington Spa,
Warwickshire CV32 4LY Tel: 0845 600 2200 Fax: 01926 423284
www.centralheating.co.uk

 Heating &
Hotwater
Information
Council

Benchmark is managed by The Heating & Hotwater Information Council

APPENDIX D

MANUAL HANDLING OF APPLIANCE PRODUCTS

Description

Manual handling means any transporting or supporting of a load (including lifting, putting down, pushing, pulling, carrying or moving) by hand or bodily force.

Scope

This assessment will cover the largest Appliance, namely ElectraMate, GulfStream, BoilerMate, SysteMate, PulsaCoil, Accolade and Stainless Lite manufactured by Gledhill.

The maximum weight of the largest product in each range is 98kg and the size is 595 x 595 x 2020 mm high.

Main Hazards

Vision may not be clear due to the size of the products.

Adopting an incorrect method of lifting may cause injury, attempting to lift these products will require help from others. (Team lifts)

Control Measures

Manual lifting procedure

The lift, key factors in safe lifting are:

- a. **Balance**
- b. **Position of back**
- c. **Positioning of the arms and body**
- d. **The hold**
- e. **Taking the lead for team lifts**

- a. **Balance** - Since balance depends essentially upon the position of the feet, they should be apart about hip breadth with one foot advanced giving full balance sideways and forward without tension. In taking up this position, lifting is done by bending at the knees instead of the hips and the muscles that are brought into use are those of the thigh and not the back.
- b. **Position of back** - Straight - not necessary vertical. The spine must be kept rigid, this coupled with a bent knee position, allows the centre line of gravity of the body to be over the weight so reducing strain.
- c. **Positioning of arms and body** - The further arms are away from the side, the greater the strain on the shoulders, chest and back. Keep elbows close to the body arms should be straight.
- d. **The hold** - Before lifting ensure you have a good hold. Two handles are provided on Appliance products at the top rear side, these allow one or two persons to have a purposely-designed hold at the top of the appliance to ensure easy lifting at the top of the product. Each appliance is supplied with a pallet, which has been attached to the unit via the packaging. The pallet will also allow for one or two persons to get a good hold.

- e. **Taking the lead for team lifts**- As more than one person is required for these products ensure that one person is taking the lead. **This may be you** so ensure that each person that is helping is made aware of the weight and of the items listed within this assessment. Make sure you and any others helping know the route you intend to take that it is clear of any obstructions. Never jerk the load as this will add a little extra force and can cause severe strain to the arms, back and shoulders. If there are steps involved decide on where you will stop and take a rest period. Move smoothly and in unison taking care to look and listen to others helping with the lift. Where possible use a sack truck to move the product over long flat distances, only lift the products when necessary. If in doubt stop and get more help. The unit handles and packaging with the pallet have been designed to ensure that two-four people can assist when lifting up stairs or over longer distance.

Individual capability

Individual capability plays an important part in handling these products. Persons above average build and strength will find it easier and should be in good health. Persons below average build and strength may require more rest periods during the handling process.

Pregnant women should not carry out this operation.

Persons who are not in good health should seek medical advice prior to commencing any lifting or manual handling operation.

Residual risk

Following the guidelines given above will reduce any risk to injury.

All persons carrying out this operation must be fully trained and copies of the specific risk assessment made available for inspection and use in their training process.

Further guidance on Manual Handling can be obtained from the Health and Safety Executive. Manual Handling Operations Regulations 1992.

Gledhill (Water Storage) Ltd

AMD, JUNE 2008

CONDITIONS OF SALE & GUARANTEE TERMS

1. Gledhill (Water Storage) Ltd ("Gledhill" or "Gledhills") only its business upon the Conditions which appear below and are set out. Unless we so agree in writing these Conditions shall apply to all supply of goods by us to the satisfaction of any Conditions or terms sought to be imposed by any purchaser. These Conditions of Sale and Warranty Terms override those which are contained on the invoice forms and all Sales are made subject to these Conditions of Sale and Warranty terms only.

2. PRICE

Once an order or call off has been accepted the price will be held for three months but if delivery is estimated beyond that period at the customer's request, then we reserve the right to amend the price when necessary. The company reserves its pricing annually to adjust for changes in our cost base. We reserve the right to alter prices at any time for various reasons in our materials (notably copper and steel). If there is to be a change we will give customers at least 30 days notice but anything delivered after that date will be at the revised price. An order may not be cancelled or varied after acceptance without the written consent of the company. Such cancellation or variation shall be subject to such reasonable charges as may be appropriate.

3. SPECIFICATION

The goods are supplied in accordance with the Specifications (if any) submitted to the Purchaser and any additions and alterations shall be the subject of an extra charge. Any goods not so specified shall be in accordance with our printed literature or the literature of any of our component suppliers (subject to any modifications made above) or, if we accept any changes in construction or design of the goods, or in the specifications printed in our literature, the Purchaser shall accept the goods as changed in addition to the order.

4. PAYMENT

The invoice price of goods shall be payable within 30 days of dispatch by us of our invoice for the goods or such longer time as may be stated by our quotation or invoice. Even where payment is in full on delivery the date shall be the date on which we issue an appropriate settlement document except where we have quoted a special net price. If payment is not received in full on or before the due date we shall be entitled in addition to the invoice price to:

- (a) payment of a sum equal to any increase in the copper price supplement applicable to the particular goods sold between the date of receipt of order and the date of receipt of payment in full; and
- (b) interest on any part of the invoice price unpaid after the due date at the rate of 3% per annum over the base rate for the time being of the Bank of England.

5. TITLE

We give estimates of delivery dates (against GVA) and time of delivery is not set shall be made of the success of any contract set shall not be liable for any loss or damage occasioned by delay in delivery.

6. DELIVERY

We deliver normally by our own vehicles within 25 miles of any of our manufacturing depots. Delivery to any place more than 25 miles from one of our manufacturing depots may be subject to our special delivery charges. We reserve the right to make delivery of goods contained in one order by separate or more than one consignment and at different times. Where a point is agreed for delivery and such point is not obtained by our Agreement, the Purchaser shall take delivery within that period. If the Purchaser fails to take delivery, we shall be entitled at the Purchaser's risk and expense to store the goods at the Purchaser's premises or elsewhere and to demand payment as if they had been dispatched. Off loading at point of delivery shall be the responsibility of and be undertaken by the Purchaser.

7. INSPECTION OR DAMAGE

Goods need to be inspected before signature of delivery note and any damage, short age or discrepancy noted on the delivery note and the goods returned on the same vehicle. The buyer must also give us immediate written notice of the damage, shortage or discrepancy so that we may prompt investigation.

8. RETURN OF GOODS

Goods may not be returned to the Company except by prior written permission of an authorized officer of the Company and such return shall be subject to payment by the Purchaser of forwarding and re-stocking charges, transport and all other costs incurred by the Company.

9. COMPANY LIABILITY AND GUARANTEE

9.1. Subject to the terms of these Conditions of Sale and the standard Terms and Conditions provided Guarantees in respect of specific products as set out in this clause.

9.2. Each Guarantee is strictly conditional upon the following:

- 9.2.1. Complaints must be given to us immediately, before any action is taken, in respect of which we cannot be accepted if repairs or services are attempted on site without our written approval.
- 9.2.2. The unit has been installed in accordance with manufacturer's and service instructions and all relevant codes of practice and regulations in force at the time of installation.
- 9.2.3. All relevant inlet controls and safety valves have been fitted correctly.
- 9.2.4. The unit has only been used for the storage of potable water supplied from the public mains.
- 9.2.5. Where appropriate the unit has been regularly maintained as detailed in the installation and service instructions.

9.2.6. Defects caused by corrosion or scale deposits are not covered by any Guarantee.

9.2.7. Where we agree to rectify any defect we reserve the right to undertake the work on our own premises.

9.3. Guarantees are provided in respect of specified goods supplied by Gledhills as follows:

(a) Domestic and Commercial Open Vent Copper Cylinders and Tanks

The copper storage vessel is guaranteed for ten years and if it proves to be defective either in materials or workmanship, we will either repair or supply replacement at our option with the closest substitute in the case of any obsolete parts to any address in Great Britain.

(b) Use of all charge during the first year after delivery by us.

(c) Thereafter at a charge of one-tenth of the then current list price and any copper price supplement and delivery charge during the second year after delivery by us and increasing by a further one-tenth on the second and subsequent anniversary of delivery by us.

(d) Domestic Water-Pool Products (Primary Storage)

The copper storage vessel is guaranteed for five years and if it or any integral pipework as part of the storage vessel assembly proves to be defective either in materials or workmanship, we reserve the right to either repair or supply replacements or the closest possible substitute in the case of any obsolete product and will collect and deliver to any address in England, Wales and Scotland (including all Scottish islands).

(e) Use of all charge during the first year after delivery by us.

(f) Thereafter at a charge of one-tenth of the then current list price and any copper price supplement and delivery charge during the second year after delivery by us increasing by a further one-tenth on the second and subsequent anniversary of delivery by us.

(g) Integrated Boiler and Storage/Pool Products and Stand Alone Boilers

In the case of the Gledhills range of products and the Edcliffe range of products, Edcliffe guarantees the heat exchanger (coil) for material and construction faults for two years. THE RESPONSIBILITY FOR THE EXECUTION OF THIS GUARANTEE LIES WITH THE INSTALLER.

The guarantee becomes null and void if the appliance is used incorrectly, or in the event of power negligence or incorrectly implemented repairs OR FAILURE TO CLIMB BY THE DESIGNATED INSPECTORY AUTHORITY. The guarantee also becomes null and void if changes are made to the appliance without our knowledge, or if the serial number on the appliance is removed or made illegible.

The annual service must be carried out by a competent installer in accordance with the advice given by Gledhill and using Gledhill approved parts.

(h) Stainless Steel Unvented Cylinders

Gledhill guarantees the components including gaskets, valves and electrical parts for two years from the date of purchase. IT SHOULD BE NOTED THAT THE FACTORY FITTED TEMPERATURE AND PRESSURE RELIEF VALVE MUST NOT BE REMOVED OR ADJUSTED IN ANY WAY OR THE GUARANTEE WILL NOT BE VALID. GLEDHILL WILL NOT BE RESPONSIBLE FOR ANY CONSEQUENTIAL LOSS OR DAMAGE HOWEVER IT IS CAUSED.

The guarantee for the stainless steel vessel is for twenty five years if the original unit is returned to us AND PROVIDED THAT:

- (i) It has been installed as per the Design, Installation & Servicing Instructions, relevant standards, regulations and codes of practice.
- (ii) It has not been modified other than by Gledhill.
- (iii) It has not been subjected to seismic or improper use or full overload etc.
- (iv) It has only been used for the storage of potable water.
- (v) It has not been subjected to fire damage.
- (vi) The benchmark log book is completed after each annual service.
- (vii) The unit has been serviced annually.

It should be noted that the guarantee does not cover:

- the effects of scale build up
- any labour charges associated with replacing the unit or parts.

If the stainless steel vessel proves to be defective either in materials or workmanship we reserve the right to either repair or supply replacements or the closest possible substitute in the case of any obsolete product and will collect and deliver to any address in England, Scotland and Wales (including all islands):

(i) Use of all charge during the first year after delivery by us.

(ii) Thereafter at a charge of one-tenth of the then current list price during the second year after delivery by us and increasing by a further one-tenth on the second and subsequent anniversary of delivery by us.

ACTION IN THE EVENT OF FAILURE

If the stainless steel cylinder develops a leak we will either a deposit against the supply of a new one. This will be refunded if the failure is within the terms of the warranty when it has been confirmed by us.

(j) Solar Panels and ancillary equipment

Gledhill provides a five year warranty for defects in the collector (except broken glass and collector accessories as noted above). If the collector demonstrably fails to meet one of the requirements of the standard BS1497 part 3 we will replace it free of charge based on the date of invoice. We cannot be responsible for damage caused by mechanical stress and/or damage caused by weather related influences. The warranty includes minor surface damage that does not affect performance or installation due to improper assembly or installation.

Please note:

- Installation must have been carried out by a licensed specialist company (installing contractor or plumber) following the version of installation instructions in force.
- Edcliffe or its representative will give the opportunity to check complaints on site immediately after any defect occurred.
- Installation notes that the system was commissioned properly and that the system was checked and maintained per performance annually by a specialist company licensed for this purpose.

(k) Components of our products other than Storage Vessels and Integral Pipework
We will either refund to the purchaser the same amount of warranty as we are given by the manufacturer of the component or if the manufacturer does not give any warranty, replace free of charge any component which becomes defective within two years after the date of the delivery by us and is returned to us at the purchaser's expense but we shall not be liable for the cost of removal or shipping or return of the component or any other cost charges or damage incurred by the purchaser.

If the appliance manufacturer by Gledhill incorporates a factory fitted scale inhibitor then during the period

of three years from the date of delivery Glashall will replace, free of charge, any photo heat exchanger fitted in the appliance as original equipment in which no safe installation access that substantially reduces the effectiveness of the photo heat exchanger. This guarantee does not extend to any other component installed within the Glashall appliance or elsewhere in the Purchaser's domestic water system.

6.A.

6.A.1. In respect of goods supplied by us and in respect of any installation work carried out by us or our install, our entire liability and the purchaser's sole recourse (subject to the Guarantee) shall be as follows:-

- (a) the accept liability for death or personal injury to the extent that it results from negligence or that of our employees
- (b) Subject to the other provisions of this clause if we accept liability for direct physical damage to tangible property to the extent that such damage is caused by negligence or that of our employees, agents or subcontractors.
- (c) Our total liability in the purchase or over and above any liability to replace under the Guarantee (whether in contract or in tort including negligence) in respect of any one claim of loss or damage claimed to result from any breach of our obligations hereunder, shall be limited to actual money damages which shall not exceed £20,000 provided that such monetary limit shall not apply to any liability on the part of ourselves referred to in paragraph (a) above
- (d) Except as provided in paragraph (a) above but otherwise not withholding any provision herein contained in no event shall we be liable for the following loss or damage howsoever caused and even if then caused by us or our subcontractors:
 - (i) economic loss which shall include loss of profits, business revenue, goodwill or anticipated savings
 - (ii) damage in respect of special interest or consequential loss or damage (other than death, personal injury and damage to tangible property)
 - (iii) any claim made against the purchaser by any other party (save as expressly provided in paragraph (b) above)
- (e) Except in respect of our liability referred to in paragraph (a) above no claim may be made or action brought (whether in contract or in tort including negligence) by the purchaser in respect of any goods supplied by us more than one year after the date of the incident in the relevant goods.
- (f) Without prejudice to any other terms we shall not be liable for any water damage caused directly or indirectly as a result of any leak or other defect in the goods. We warrant the condition of use of the goods or the time or manner or location in which they will be installed and the purchaser agrees to be fully responsible for testing and checking all vents which include the goods at all relevant times (pre, during and after commissioning) and for taking all necessary steps to identify any leaks and prevent any damage being caused thereby.
- (g) Nothing in these Conditions shall confer on the purchaser any rights or remedies to which the purchaser would not otherwise be legally entitled

10. LIMIT OF REMEDY

Notwithstanding any other provision contained herein the purchaser's liability agrees to fully indemnify us against any damage, losses, costs, claims or expenses incurred by us in respect of any claim brought against us by any third party:-

- (a) any loss, injury or damage which is wholly caused by any goods supplied by us or their use,
- (b) any loss, injury or damage which is partly caused by the defective installation or subcontracted workmanship or materials used in the installation of any goods supplied by us,
- (c) any loss, injury or damage in any way connected with the performance of this contract,
- (d) any loss resulting from any failure by the purchaser to comply with its obligations under these terms as to install and/or check vents correctly.

PROVIDED that this paragraph will not require the purchaser to indemnify us against any liability for our own acts of negligence or those of our employees, agents or subcontractors.

FURTHER in the case of goods supplied by us which are re-sold and installed by a third party by the purchaser we will be the sole responsibility of the purchaser to test the goods immediately after their installation to ensure that when they are correctly installed and in proper working order they are free from leaks and are not likely to cause any loss, injury or damage to any person or property.

11. WAIVER OF WARRANTY AND EXCLUSION

Should our warranty and exclusion be unacceptable we are prepared to negotiate for variation in their terms but only on the basis of an increase in the price to allow for any additional liability or risk which may result from the variation.

Purchaser are able to waive against any risk or liability which they may incur and which is not caused by our remedy.

12. RELEASE BY PURCHASER OF TITLE

- (a) goods supplied by us shall be at the Purchaser's risk immediately upon delivery to the Purchaser or into custody on the Purchaser's behalf or in the Purchaser's Domicile. The Purchaser shall effect adequate insurance of the goods against all risks in their full location value of the goods, such insurance to be at least as broad as the time of delivery until property in the goods shall pass to the Purchaser as hereinafter provided.
- (b) property in the goods supplied hereunder shall pass to the Purchaser when full payment has been made by the Purchaser to us for:-
 - (i) the goods of the subject of this contract.
 - (ii) all other goods the subject to of any other contract between the Purchaser and us which, at the time of payment of the full price of the goods and under this contract, have been delivered to the Purchaser but not paid for in full.
- (c) until property in the goods supplied hereunder passes to the Purchaser in accordance with paragraph (b) above:
 - (i) the Purchaser shall hold the goods in a fiduciary capacity for us and shall store the same separately from any other goods in the Purchaser's possession and in a manner which enables them to be identified as our goods.
 - (ii) the Purchaser shall immediately return the goods to us should our authorized representative so request. All the necessary incidents are contained with a fiduciary relationship shall apply.
- (d) the Purchaser's right to possess the goods shall cease forthwith upon the happening of any of the following events, namely:-
 - (i) if the Purchaser fails to make payment in full for the goods within the time stipulated in clause 4 hereof.
 - (ii) if the Purchaser, not being a company, commits any act of bankruptcy, makes a proposal to its or her creditors for a compromise or does anything which would entitle a petition for a Bankruptcy Order to be presented.
 - (iii) if the Purchaser, being a company, does anything or fails to do anything which would entitle an administrator or an administrative receiver or a receiver to take possession of any assets or which would entitle any person to present a petition for winding up or to apply for an administration order.
- (e) the Purchaser hereby grants to us an irrevocable licence to enter at any time any vehicle or premises owned or occupied by the Purchaser or in the possession of the Purchaser for the purpose of representing and

recovering any such goods the property in which has been lost in respect of paragraph (2) above. We shall not be responsible for and the Purchaser will indemnify us against liability in respect of damage caused to any vehicle or premises in such circumstances and removal being damaged which it was not reasonably practicable to avoid.

(f) notwithstanding paragraph (b) hereof and subject to paragraph (7) hereof, the Purchaser shall be permitted to sell the goods to third parties in the normal course of business. In this respect the Purchaser shall act in the capacity of our commission agent and the proceeds of such sale:-

- (i) shall be held in trust for us in a manner which enables such proceeds to be identified as such, and:-
- (ii) shall not be mixed with other moneys nor paid into an overdraw bank account.

We, as principal, shall reimburse the Purchaser as commission agent a commission depending upon the surplus which the Purchaser can obtain over and above the sum, stipulated in this contract of supply which falls due to us.

(g) in the event that the Purchaser shall sell any of the goods pursuant to clause (f) hereof, the Purchaser shall forthwith inform us in writing of such sale and of the identity and address of the third party to whom the goods have been sold.

(h) if, before property in the goods passes to the Purchaser under paragraph (2) above the goods are or become attached in any land or building owned by the Purchaser it is hereby agreed and declared that such attachment shall not have the effect of passing property in the goods to the Purchaser. Furthermore if, before property in the goods shall pass to the Purchaser under paragraph (2) hereof, the goods are or become attached to any land or building (whether or not owned by the Purchaser), the Purchaser shall:-

- (i) ensure that the goods are capable of being removed without material injury to such land or building.
- (ii) take all necessary steps to prevent title to the goods from passing to the landlord of such land or building.
- (iii) forthwith inform us in writing of such attachment and of the address of the land or building concerned.

The Purchaser warrants to repair and make good any damage caused by the attachment of the goods to or their removal from any land or building and to indemnify us against all loss, damage or liability we may incur or sustain as a result of attachment or removal.

- (i) in the event that, before property in the goods has passed to the Purchaser under paragraph (2) hereof, the goods or any of them are lost, stolen, damaged or destroyed:-
- (ii) the Purchaser shall forthwith inform us in writing of the fact and circumstances of such loss, theft, damage, destruction.
- (iii) the Purchaser shall assign to us the benefit of any insurance claim in respect of the goods so lost, stolen, damaged or destroyed.

13. NON-PAYMENT

If the Purchaser shall fail to make full payment for the goods supplied hereunder within the time stipulated in clause 4 hereof or to be default of payment for any other reason then, without prejudice to any of our other rights hereunder, we shall be entitled to stop all deliveries of goods and materials to the Purchaser, including deliveries or further deliveries of goods under this contract. In addition we shall be entitled to demand all outstanding moneys.

14. WARRANTIES

All prices quoted are exclusive of Value Added Tax which will be charged at the rate ruling at the date of dispatch of goods.

15. WHOLE SALES ONLY

We are only prepared to deal with those who are not consumers within the terms of the Unfair Contract Terms Act 1977, the Sale of Goods Act 1979 and the Supply of Goods and Services Act 1972. Accordingly any person who purchases from us should be deemed to have represented that he is not a consumer by so purchasing.

16. JURISDICTION

The agreement is subject to English law for goods delivered in England and Scottish law for goods delivered in Scotland and any dispute hereunder shall be settled in accordance therewith depending upon the location.

